

532766

Sandia National Laboratories  
Waste Isolation Pilot Plant

Analysis Package for DRSPALL:  
Compliance Recertification Application

Part I -- Calculation of Spall Volumes

Authors:	<b>David Lord (6821)</b>	<i>David L. Lord</i>	<u>11/5/2003</u>
	Print Name	Signature	Date
	<b>David Rudeen (6852)</b>	<i>David L. Lord for</i>	<u>11/6/2003</u>
	Print Name	Signature	Date
	<b>Cliff Hansen (6821)</b>	<i>Cliff Hansen</i>	<u>11/6/2003</u>
	Print Name	Signature	Date
Reviewed by:	<b>Michael Gross (CTAC)</b>	<i>Mario Chavez for</i>	<u>11/5/03</u>
	Print Name	Signature	Date
	Technical Reviewer		
Reviewed by:	<b>Mario Chavez (6820)</b>	<i>Mario Chavez</i>	<u>11/12/03</u>
	Print Name	Signature	Date
	Quality Assurance Reviewer		
Approved by:	<b>David Kessel (6821)</b>	<i>David Kessel</i>	<u>11/12/03</u>
	Print Name	Signature	Date
	Department Manager		

WIPP: 1.4.1.2:PA:QA-L:530162

Lord, David L



**From:** Rudeen, David K  
**Sent:** Thursday, November 06, 2003 8:05 AM  
**To:** Lord, David L  
**Subject:** RE: signature needed

Dave,

The final draft looks good. I authorize you to sign in my absence.

David

-----Original Message-----

**From:** Lord, David L  
**Sent:** Wednesday, November 05, 2003 3:11 PM  
**To:** Rudeen, David K  
**Subject:** signature needed

Dave-

This is the final draft that we would like to submit. We need signatures from you and Dave Kessel to proceed. If you are happy with the current draft, send me signature authority and I will sign for you. I decided against inserting Janis' table of parameters because the GROPE listing was more thorough and her table would take more work.

<< File: DRSPALL\_CRA\_ARpartI\_final.zip >>

++++  
David L. Lord, Ph.D.  
Performance Assessment & Decision Analysis  
Carlsbad Programs Group  
Sandia National Laboratories  
PH: 505-234-0055  
FX: 505-234-0061

Mailing address:  
SANDIA NATIONAL LABORATORIES  
4100 NATIONAL PARKS HWY.  
CARLSBAD, NM 88220

++++

## Table of Contents

List of Figures .....	3
List of Tables.....	4
1 Introduction .....	5
2 Methodology .....	6
2.1 Characterization of Subjective Uncertainty .....	6
2.2 Calculation of Spall Volumes .....	6
2.3 Output variable definitions.....	7
2.3.1 History variables .....	8
2.3.2 Spatial variables .....	13
3 RESULTS AND DISCUSSION .....	16
3.1 LHS sampling results .....	16
3.2 DRSPALL Summary Output .....	18
3.3 Scenario 1 (R1S1) results.....	20
3.4 Scenario 2 (R1S2) Results.....	22
3.4.1 R1S2 Cavity Radius .....	22
3.4.2 R1S2 v030 Radial Effective Stress .....	25
3.4.3 Scenario 2 Scatter plots.....	27
3.5 Scenario 3 (R1S3) results.....	28
3.5.1 Scenario 3 history plots.....	28
3.5.2 Scenario 3 radial effective stress.....	31
3.5.3 Final SPLVOL2 volumes for R1S3 .....	33
3.6 Scenario 4 (R1S4) results.....	36
3.6.1 Scenario 4 history plots.....	36
3.6.2 Special cylindrical runs, v002 & v030 .....	36
3.6.3 Scenario 4 scatter plots.....	38
4 SUMMARY .....	39
5 REFERENCES.....	40
APPENDIX LHS2_DRSPALL.TRN.....	42
APPENDIX DEFAULTS.....	49
APPENDIX SPALL_TABLE.....	51

**LIST OF FIGURES**

Figure 2-1. Radial variables in cylindrical geometry.....	9
Figure 2-2. Radial variables in spherical geometry.....	9
Figure 2-3. Schematic mapping the cavity dimensions in the real 3-D system to the 1-D radially symmetric geometry in DRSPALL.....	10
Figure 2-4. Schematic of the relationship among TOTVOLEQ, CUTVOLEQ, and SPLVOLEQ. ....	12
Figure 2-5. Volume history plot for vector 039 in spherical geometry annotated to illustrate the incremental spallings volume (SPLVOL2) variable. ....	13
Figure 2-6. Drawing of a theoretical radial effective stress curve. Material is subject to tensile failure where $\sigma_r'(r) < T_s$ .....	15
Figure 3-1. Horsetail plot of BEDDEPTH for all 50 vectors in Scenario 1. All data overlay at zero.....	21
Figure 3-2. Horsetail plot of CAVRAD for Scenario 1. ....	21
Figure 3-3. Bar graph of SPLVOL2 releases per vector for S2, ranked in ascending order. ....	22
Figure 3-4. Horsetail plot of CAVRAD for scenario 2.....	23
Figure 3-5. History plot of CAVRAD, DRILLRAD, and TENS RAD for R1S2 v030 run out to 1000 seconds.....	23
Figure 3-6. History plot of waste boundary superficial velocity (WBSUPVEL) and minimum fluidization velocity (FLUIDVEL) for S2, v030.....	24
Figure 3-7. Spatial plot of radial effective stress (RADEFSTR) near cavity wall for v030 at runtime = 750 seconds. ....	26
Figure 3-8. Scatter plots of SPLVOL2 versus the sampled waste properties of porosity, tensile strength, permeability, and particle diameter for scenario 2. ....	27
Figure 3-9. Bar graph of SPLVOL2 releases per vector for scenario 3, ranked in ascending order. ....	28
Figure 3-10. Horsetail plot of CAVRAD for scenario 3.....	29
Figure 3-11. Schematic of hemispherical spallings cavity intersecting the lower DRZ.....	30
Figure 3-12. Horsetail plot of CAVRAD for v002 and v030, cylindrical geometry, scenario 3. ....	31
Figure 3-13. Spatial plot of radial effective stress (RADEFSTR) near cavity wall for v002 in cylindrical geometry, $T_s = 1.25E+05$ Pa. ....	32
Figure 3-14. Spatial plot of radial effective stress (RADEFSTR) near cavity wall for v030 at 200 sec in cylindrical geometry, $T_s = 1.39E+05$ Pa. ....	32
Figure 3-15. Bar graph of SPLVOL2 releases per vector for scenario 4, ranked in ascending order. ....	36
Figure 3-16. Horsetail plot of CAVRAD for scenario 4.....	37
Figure 3-17. History plot of CAVRAD for v002 and v030, cylindrical geometry, scenario 4. ....	37
Figure 3-18. Scatter plots of SPLVOL2 versus sampled waste properties for porosity, permeability, tensile strength and particle diameter for scenario 4. ....	38
Figure 4-1. 3-dimensional bar chart of spallings releases calculated by DRSPALL for the 2004 WIPP CRA.....	39

**LIST OF TABLES**

Table 2-1. Summary of DRSPALL input variables, including range and distribution, sampled using LHS. ....	7
Table 2-2. Summary of scenarios used to calculate spall volumes. ....	7
Scenario number.....	7
Table 2-3. Nomenclature for Stress Calculations.....	14
Table 3-1. Results of LHS sampling. ....	16
Table 3-2. Summary of spillings releases for the 4 scenarios and 50 vectors.....	18
Table 3-3. Calculation of mean RADEFSTR over $L_t$ for S2, v030 at runtime = 750 sec.....	26
Table 3-4. Calculation of mean RADEFSTR over $L_t$ for S3, v030 at runtime = 200 sec in cylindrical geometry.....	33
Table 3-5. Excerpt from GROPECDB output file analyzing R1S3, v030 for the point when CAVRAD $\geq$ H (highlighted). ....	34
Table 3-6. SPLVOL2 values at 600 seconds for the special cylindrical runs.....	34
Table 3-7. Summary of final releases for v002 and v030, R1S3 and R1S4. Units are $m^3$ uncompacted spall volume.....	35

**Glossary of Acronyms**

<i>Acronym</i>	<i>Definition</i>
CCA	Compliance Certification Application, 1996
CDB	CAMDAT file (binary format)
CDF	Cumulative Distribution Function
CCDF	Complementary Cumulative Distribution Function
CRA	Compliance Recertification Application, 2004
DDZ	Drilling-damaged zone
US DOE	United States Department of Energy
DRSPALL	Computer code that implements the new conceptual model for spillings
LHS	Latin Hypercube Sampling
PA	Performance Assessment
PAVT	Performance Assessment Verification Test, 1997
R1S1	Replicate 1, Scenario 1
SNL	Sandia National Laboratories
TSPA	Total System Performance Assessment
WIPP	Waste Isolation Pilot Plant

## 1 INTRODUCTION

This report documents the calculation of spillings releases for the Waste Isolation Pilot Plant (WIPP) Performance Assessment (PA) for the 2004 Compliance Recertification Application (CRA). This analysis utilizes a new conceptual model for spillings relative to that used in the 1996 Compliance Certification Application (CCA). This new model and the code that implements it, DRSPALL, were developed during the period 1998-2003 by the US Department of Energy (DOE) and Sandia National Laboratories (SNL), and subsequently approved by independent peer review (Yew et al., 2003) and qualified for use in WIPP PA in 2003 (WIPP PA, 2002-2003e). This work supports the objectives in AP-096, Analysis Plan for Completion of the Spallings Model for WIPP Recertification (Lord, 2002).

The DRSPALL code (from Direct Release SPALL) calculates the total volume of WIPP waste solids potentially released to the land surface due to an inadvertent oil or gas drilling intrusion into a dry, high-pressure repository. The code calculates coupled repository and wellbore transient mixed-phase compressible fluid flow before, during, and after the drill bit intrudes into the repository. Models are included of bit penetration, mixed-phase (mud, salt, waste, and gas) fluid flow in the wellbore, fluid expulsion at the surface, coupling of fluid flow in the wellbore and the repository, spalling (tensile) failure of waste, fluidized bed transport of failed waste, and repository internal gas flow. The wellbore flow model is one-dimensional with linear flow, while the repository flow model is one-dimensional with radial flow in either a spherical or cylindrical geometry.

## 2 METHODOLOGY

The calculation of spallings releases for CRA is divided into four steps: (1) characterization of subjective uncertainty in calculation of spall volumes; (2) calculation of spall volumes using DRSPALL accounting for subjective uncertainty in waste properties; (3) implementation of DRSPALL results in the code CUTTINGS\_S to calculate spall volumes in the scenarios for drilling intrusions; (4) calculation of spall releases accounting for stochastic uncertainty in the future of the repository using the code CCDFGF. The current report, Part I of a series, describes the first two steps: characterization of subjective uncertainty and the DRSPALL calculations for spall volumes. Implementation of the DRSPALL results and the calculation of spallings releases are covered in Part II.

### 2.1 Characterization of Subjective Uncertainty

Preliminary sensitivity analyses (Lord and Rudeen, 2003) identified five input variables that largely control the spall volume calculated by DRSPALL. These variables include repository initial gas pressure, porosity of waste local to the borehole, permeability of waste local to the borehole, tensile strength of the solid waste aggregate, and particle diameter of the failed waste. Repository initial pressure is an initial condition to the calculation of spall volume that is determined by repository conditions at the time of the drilling intrusion. The other four variables are treated as subjectively uncertain parameters. Table 2-1 lists these variables and the distribution used for these parameters. Justification for selection of the sampled ranges and distributions in Table 2-1 is given in Hansen et al. (2003). Latin Hypercube Sampling (LHS) was used to create a total of fifty sets of input parameters for DRSPALL; each set of input parameter values is referred to as a “vector.”

### 2.2 Calculation of Spall Volumes

The other input variable, repository pressure, depends on the time and location of the intrusion as well as the times and locations of previous intrusions. The long DRSPALL run time (> 1 hour) for a typical vector precludes calculation of spall volume for every intrusion. Instead, spall volumes are computed for four discrete values of repository pressure, resulting in four DRSPALL scenarios. Table 2-2 lists the pressures used in each scenario.

All DRSPALL input parameter values not listed in Tables 2-1 and 2-2 are constant in this analysis. The combination of the 50 vectors from the LHS sampling of subjectively uncertain parameters and the 4 scenarios result in 200 separate DRSPALL runs. This approach is much more efficient than running DRSPALL for each intrusion.

*Table 2-1. Summary of DRSPALL input variables, including range and distribution, sampled using LHS.*

<i>Variable Name</i>	<i>Units</i>	<i>Distribution</i>	<i>Low</i>	<i>High</i>
Porosity of Waste	-	UNIFORM	0.35	0.66
Permeability of Waste	m <sup>2</sup>	LOGUNIFORM	2.4E-14	2.4E-12
Tensile Strength of Waste	Pa	UNIFORM	1.2E+05	1.7E+05
Particle Diameter	m	LOGUNIFORM	1.0E-03	1.0E-01

*Table 2-2. Summary of scenarios used to calculate spall volumes.*

<i>Scenario number</i>	<i>Pressure (Pa)</i>
1	10.0E+06
2	12.0E+06
3	14.0E+06
4	14.8E+06

The four pressure scenarios span a range from 10.0 to 14.8 MPa. These endpoints were determined based on extensive sensitivity testing conducted in support of the spallings conceptual model peer review, and documented in reports by Lord and Rudeen (2003). These analyses determined that no tensile failure of repository material was observed at initial repository pressure less than 10 MPa, and no spallings were observed at pressure less than 13 MPa. Thus, the lower bound for executing DRSPALL is 10 MPa, below which waste failure and subsequent transport for spallings is assumed to be non-existent. The high end of the pressure range is limited by the far-field stress input parameter to DRSPALL, defined in Hansen et al. (2003) as  $\sigma_{ff} = 14.9$  MPa. Thus, the upper limit of pressure sampling is 14.8 MPa, the closest value less than  $\sigma_{ff}$  with the same precision of three significant digits. It is acknowledged that repository pressure greater than 14.8 MPa may occur in the TSPA analysis. For these cases, the release volumes from the 14.8 MPa DRSPALL runs will be used.

### **2.3 Output variable definitions**

A comprehensive list of variable definitions is given in the DRSPALL User's Manual (WIPP PA, 2003d). The important history and spatial variables for determining the spalled volume are listed below.

History (time dependent) variables:

1. Radial
  - a. Cuttings radius (CUTRAD)
  - b. Cavity radius (CAVRAD)



- c. Tensile-failed radius (TENSRAD)
2. Velocity
  - a. Minimum fluidization velocity (FLUIDVEL)
  - b. Waste boundary superficial velocity (WBSUPVEL)
3. Equivalent uncompacted volumes
  - a. Total (TOTVOLEQ)
  - b. Cuttings (CUTVOLEQ)
  - c. Spallings (SPLVOLEQ)
  - d. Incremental spall volume (SPLVOL2)

Spatial (radially dependent) variables:

1. Radial effective stress (RADEFSTR)

### **2.3.1 History variables**

#### **2.3.1.1 Radial variables**

The definition of radius is a key variable in the DRSPALL model because some history and all spatial variables in the 1-D cylindrical and spherical geometries are all expressed as a function of radius. The origin for the cylindrical geometry is a line down the center of the borehole denoting the axis of symmetry (Figure 2-1). The origin for the spherical repository domain is a point where the axis of the drill bit first touches the top of the repository (Figure 2-2).

The three primary variables that define the cavity in DRSPALL output are the drill cuttings radius, the cavity radius, and the tensile-failed radius. The relationship among these three variables is demonstrated in Figures 2-1 and 2-2. The easiest place to start is with the cutting radius. This parameter represents the position of the drill bit face in the repository. In many DRSPALL vectors, drilling is the only mechanism that expands the cavity, so the drill radius and cavity radius are identical. In the event of spallings, however, the cavity radius may become larger than the drilled radius. This implies that the spallings mechanism has removed material ahead of the drill bit. A third cavity parameter, the tensile-failed radius, is also important to monitor because this variable identifies solid material that has failed due to the stress state, but has not mobilized into the flow stream. The tensile-failed radius is equal to or greater than the cavity radius, but it can never be smaller.

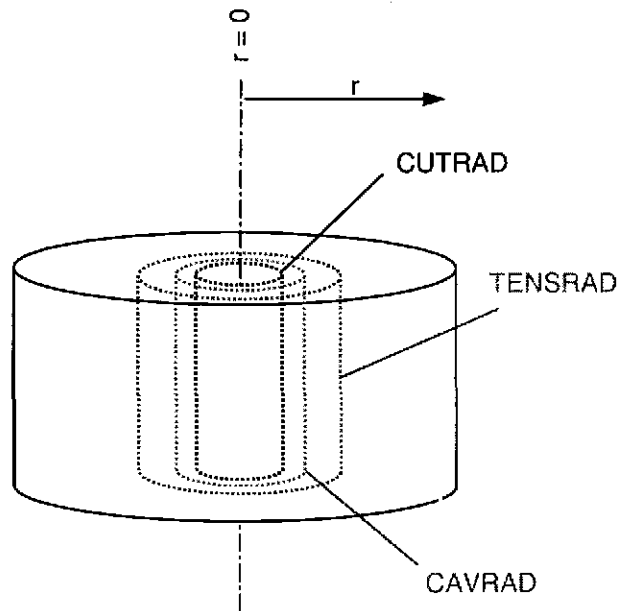

Figure 2-1. Radial variables in cylindrical geometry.

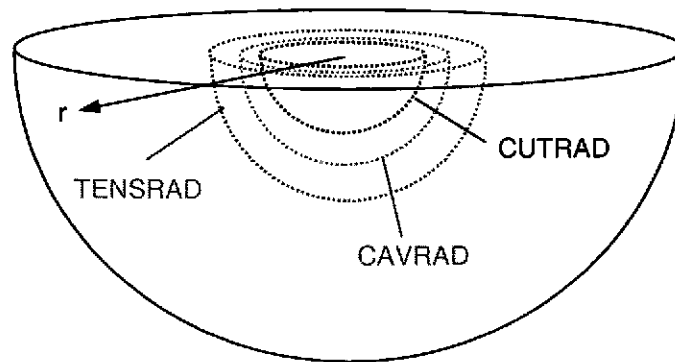

Figure 2-2. Radial variables in spherical geometry.

### 2.3.1.2 Mapping the cuttings radius in DRSPALL geometry

Drill cuttings in the real 3-D system is mapped to an equivalent 1-D cuttings radius by conserving the surface area of the expanding cavity. For the cylindrical geometry, this involves starting with a narrow cylinder that extends through the entire repository height along the drilling axis, and expanding the radius as the real bit penetrates downward. For the spherical geometry, this requires defining a small hemisphere that has its origin at the point where the drill bit would first intersect the repository, and expanding this hemisphere radially as the bit proceeds. Drilling continues in both geometries for the amount of time required for a real bit to penetrate the entire depth of the repository. This implies that the rate of areal expansion of the drilled cavity is the same in all systems. A schematic of the mapping is given in Figure 2-3 for the spherical geometry at the point when drilling is complete for a repository of height = 1.23 m. The length scale on the figures is equivalent. The equivalent cavity radius in DRSPALL in this case is 0.45 m, which is nearly 1.5× the wellbore diameter, and about 1/3 of the repository height. More detail on the mapping among geometries is given in the *Design Document for DRSPALL, document version 1.10* (WIPP PA, 2003a).

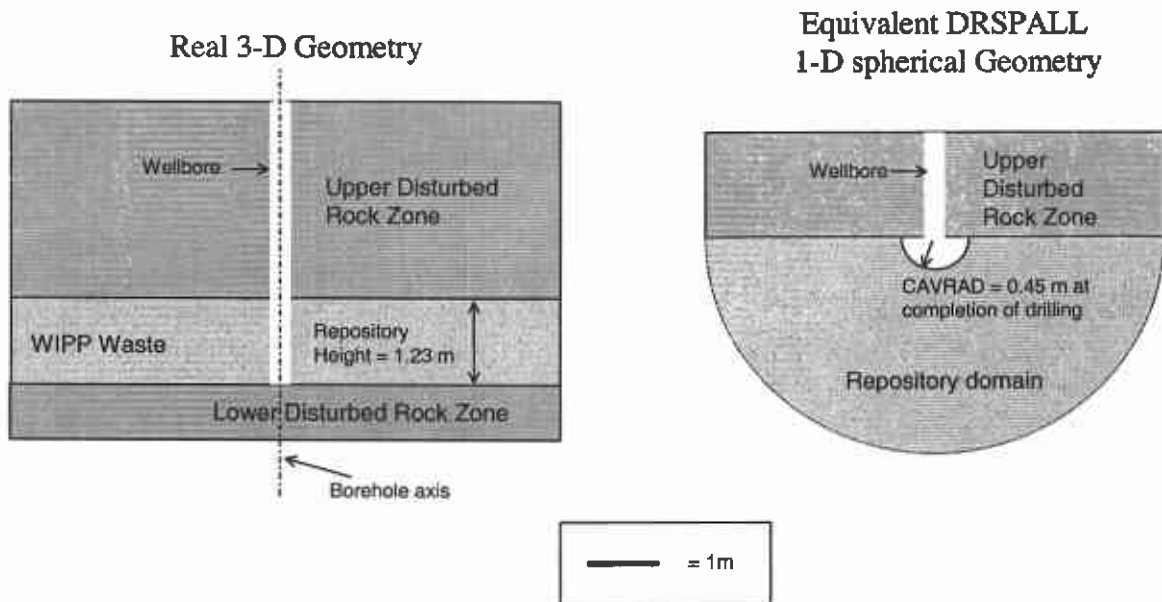

Figure 2-3. Schematic mapping the cavity dimensions in the real 3-D system to the 1-D radially symmetric geometry in DRSPALL.

### 2.3.1.3 Velocity variables

The minimum fluidization velocity (FLUIDVEL) and the waste boundary superficial velocity (WBSUPVEL) describe conditions that either allow or prevent fluidized bed transport of disaggregated (failed) waste from the cavity to the wellbore. The minimum fluidization velocity derives from fluidized bed theory developed by Ergun (1952). In the event that superficial gas velocity moving through a packed bed of particulate solids exceeds the minimum fluidization velocity, the bedded material will become fluidized and entrained in the flow stream. The waste boundary superficial velocity in DRSPALL is defined as the volume flow rate divided by the cavity surface area. More detail on the fluidized bed model in DRSPALL is given in the *Design Document for DRSPALL, document version 1.10* (WIPP PA, 2003a).

### 2.3.1.4 Equivalent uncompacted volumes

DRSPALL calculates the mass of repository solids ejected to the land surface. For the purpose of comparing these release masses to spall releases from 1996 CCA and 1997 Performance Assessment Verification Test (PAVT) analyses (MacKinnon and Freeze, 1997), the DRSPALL expelled masses are converted to “equivalent uncompacted volume” units:

$$V_{eq} = \frac{m_s}{\rho_s (1 - \phi_o)} = \frac{V_s}{(1 - \phi_o)} \quad (2.1)$$

where  $V_{eq}$  is the equivalent volume prior to compaction,  $m_s$  is the solids mass ejected at the surface,  $\rho_s$  is the solids density,  $V_s$  is the solids volume and  $\phi_o$  is the porosity of a waste-filled room prior to closure. Values of  $\rho_s = 2650 \text{ kg/m}^3$  (Appendix DEFAULTS) and  $\phi_o = 0.85$  (DOE, 1996: Appendix PAR, Table PAR-38) are used in this analysis. These values applied in Eq. 2.1 result in an equivalent uncompacted volume about 6.7 times larger than solid volume.

DRSPALL distinguishes between equivalent uncompacted volume of repository removed by all processes (TOTVOLEQ), and material released by spillings (SPLVOLEQ), which is evaluated by subtracting the equivalent volume of material removed by drilling action (CUTVOLEQ), or cuttings, from TOTVOLEQ. This is shown schematically for the hemispherical repository geometry in Figure 2-4.

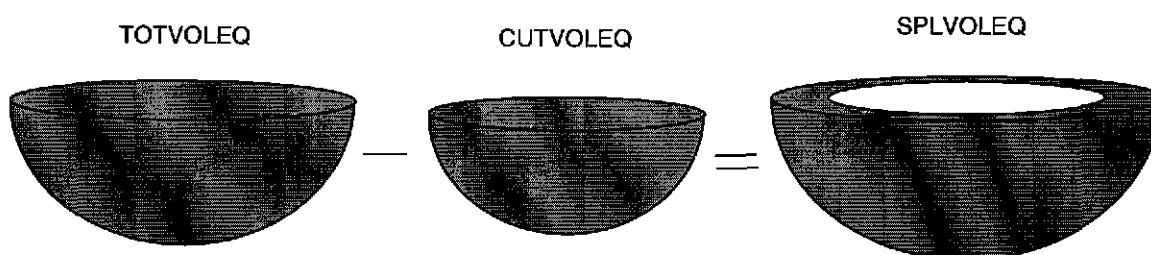

*Figure 2-4. Schematic of the relationship among TOTVOLEQ, CUTVOLEQ, and SPLVOLEQ.*

In addition to reporting the equivalent uncompact spall volumes (SPLVOLEQ), DRSPALL defines another release variable, the incremental spall volume (SPLVOL2), that quantifies the amount of solid material removed due to failure and fluidization, regardless of whether it would eventually be drilled out by bit action. The purpose of defining this variable is to monitor the volume of waste removed by spalling, independent of the position of the drillbit.

Recall that the equivalent uncompact spall volume is the difference between the final cavity volume (TOTVOLEQ) and the drilled cavity volume (CUTVOLEQ) as depicted in Figure 2-4. In some vectors, repository material is removed ahead of the bit due to failure and fluidization, though such failed material that is eventually drilled out is not captured in the SPLVOLEQ variable at late time. An example of this is shown in Figure 2-5 where the equivalent uncompact volume and incremental spall volume are plotted versus time for vector 039. Note the six spikes in the SPLVOLEQ curve between 150 and 300 seconds. These spikes represent removal of repository material due to tensile failure and fluidization. This material transports up the wellbore and is ejected to the land surface in the same way that drilled material is, but just slightly earlier in time.

While SPLVOLEQ goes down because drilling catches up with the spalled cavity radius, SPLVOL2 distinguishes between material that is removed by failure and fluidization mechanisms and material that is removed by drilling. Therefore, SPLVOL2 cannot decrease and is always greater than or equal to SPLVOLEQ. The spall volumes for the CRA are the SPLVOL2 release volumes.

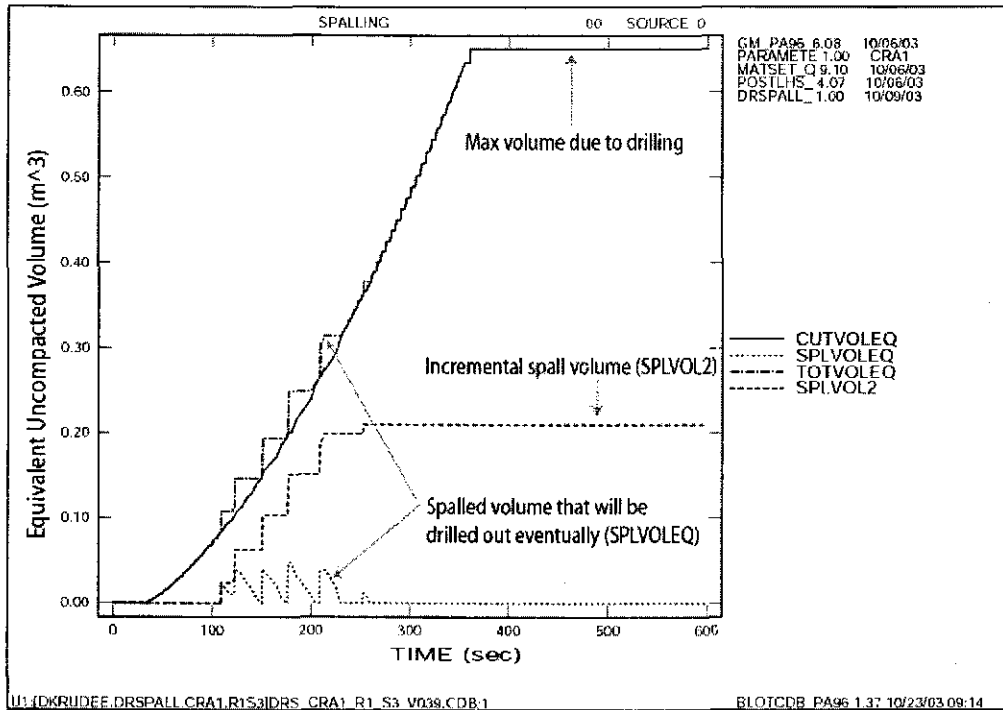

Figure 2-5. Volume history plot for vector 039 in spherical geometry annotated to illustrate the incremental spillings volume (SPLVOL2) variable.

### 2.3.2 Spatial variables

#### 2.3.2.1 Radial effective stress

In DRSPALL, the radial effective stress at any radius  $r$  is calculated as the sum of the radial seepage and elastic stress, minus the pore pressure:

$$\sigma_r'(r) = \sigma_{sr}(r) + \sigma_{er}(r) - \beta p(r) \tag{2.2}$$

where the radial seepage stress is evaluated with the following integral:

$$\sigma_{sr}(r) = (m-1)\beta \left( \frac{1-2\nu}{1-\nu} \right) \frac{1}{r^m} \int_{r_c}^r (p(r) - p_{ff}) r^{m-1} dr \tag{2.3}$$

and the radial elastic stress is evaluated as:

$$\sigma_{er}(r) = \left\{ \sigma_{ff} \left[ 1 - \left( \frac{r_c}{r} \right)^m \right] + p_c \left( \frac{r_c}{r} \right)^m \right\} \quad (2.4)$$

and the pore pressure,  $p(r)$ , is obtained from the transient solution to porous flow. The terms for Equations 2.2-2.4 are defined in Table 2-3.

Table 2-3. Nomenclature for Stress Calculations

Symbol	Definition	Units
$m$	Geometry exponent ( $m=3$ for spherical, $m=2$ for cylindrical)	–
$p(r)$	Gas pressure at a distance $r$ from wellbore axis	Pa
$p_c$	Pressure at cavity face	Pa
$p_{ff}$	Pressure in far-field (constant)	Pa
$r$	Radius	m
$r_c$	Radius at cavity face	m
$T_s$	Tensile strength	Pa
$\beta$	Biot's constant	–
$\sigma_{ff}$	Stress in far-field (constant)	Pa
$\sigma_{sr}(r)$	Radial seepage stress	Pa
$\sigma_{er}(r)$	Radial elastic stress	Pa
$\sigma_r'(r)$	Radial effective stresses	Pa
$\nu$	Poisson's ratio	–
$L_t$	Characteristic length for testing tensile failure	m
$i$	Zone index in discretized repository domain	–

Details of the theoretical origins of the DRSPALL stress model are given in the *Design Document for DRSPALL, document version 1.10* (WIPP PA, 2003a).

### 2.3.2.2 Tensile failure

Tensile failure of the solid waste material is determined by comparing the radial effective stress ( $\sigma_r'(r)$ ) profile near the cavity wall to the tensile strength  $T_s$  of the solid, shown graphically in Figure 2-6. DRSPALL uses the convention that a positive stress denotes compression, while a negative stress denotes tension. The maximum effective radial stress in tension (where  $\sigma_r'(r) < 0$ ) will typically occur near the cavity wall and transition to compression ( $\sigma_r'(r) > 0$ ) as  $r$  increases to the far-field. Therefore, tensile failure in the waste occurs near the cavity wall.

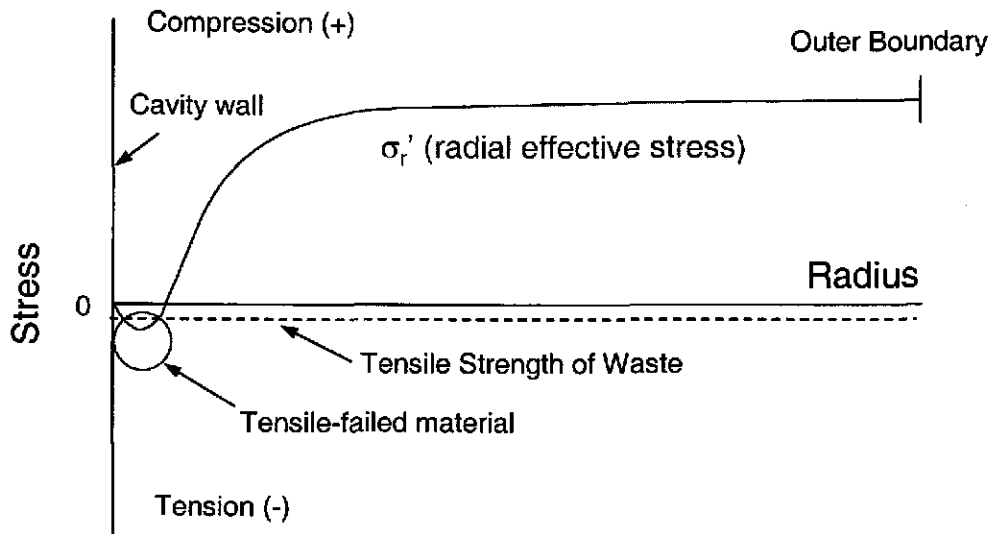

Figure 2-6. Drawing of a theoretical radial effective stress curve. Material is subject to tensile failure where  $\sigma_r'(r) < T_s$ .

Waste failure in DRSPALL occurs only when the mean radial effective stress (in tension) over a characteristic length,  $L_t$ , exceeds the tensile strength. In the discretized repository domain, the failure criterion is tested according to the following expression:

$$\text{if } \frac{\sum_{i=1}^n \sigma_{r,i}}{n} < T_s, \text{ then failure is initiated for the } n \text{ zones within } L_t. \quad (2.5)$$

The sum is evaluated over  $n$  repository zones covering a characteristic length  $L_t$  next to the cavity boundary. Note that since  $T_s$  is represented by a negative constant in the current calculations, a tensile stress exceeding  $T_s$  equates to a value less than  $T_s$ , hence the “less than” symbol in Eq. 2.5.  $L_t$  for the CRA analysis with DRSPALL is 2 cm.

The characteristic length concept is introduced because (1) the model assumes failure is initiated at the cavity wall, and (2) the stress formulations in Eqs. 2.2 – 2.4 preclude tensile failure in the first few zones at the cavity wall if the zones are small enough. Close examination of Eqs. 2.2 – 2.4 will reveal that the radial effective stress is exactly zero at the cavity wall. This is also illustrated in Figure 2-6. A zone size can always be found in which the very first zone representing the cavity wall has an effective stress insufficient to fail the waste. Also, numerical noise at the cavity boundary can cause spurious failure of the first zone, independent of the physical conditions in the simulation. For these reasons, a characteristic length is introduced that averages the stress over the first several repository zones to capture the expected physical behavior near the cavity wall, rather than allow failure, or lack thereof, from numerical artifacts.



### 3 RESULTS AND DISCUSSION

#### 3.1 LHS sampling results

The results of the LHS sampling are summarized in Table 3-1. Recall that there are 50 vectors (rows) with 4 sampled variables (columns). The porosity of the waste, the permeability of the waste, the tensile strength of the waste, and the particle diameter are denoted by REPIPOR, REPIPERM, TENSLSTR, and PARTDIAM, respectively. All other input variables are constants, with values given in Appendix DEFAULTS.

*Table 3-1. Results of LHS sampling.*

<b>Vector</b>	<b>REPIPOR (-)</b>	<b>REPIPERM (m<sup>2</sup>)</b>	<b>TENSLSTR (Pa)</b>	<b>PARTDIAM (m)</b>
1	5.17E-01	3.97E-13	1.38E+05	4.69E-02
2	3.77E-01	5.77E-14	1.25E+05	3.88E-03
3	6.24E-01	3.90E-14	1.47E+05	7.72E-02
4	6.41E-01	5.49E-14	1.39E+05	2.13E-03
5	4.91E-01	7.22E-14	1.52E+05	1.11E-02
6	6.32E-01	8.82E-13	1.66E+05	2.96E-03
7	5.69E-01	4.28E-14	1.64E+05	2.39E-02
8	6.04E-01	2.42E-14	1.55E+05	3.80E-02
9	5.33E-01	7.55E-13	1.30E+05	1.07E-02
10	6.12E-01	1.03E-13	1.60E+05	7.51E-02
11	4.85E-01	3.05E-13	1.23E+05	5.82E-02
12	5.38E-01	2.81E-13	1.31E+05	6.80E-02
13	4.52E-01	1.27E-12	1.50E+05	5.60E-02
14	4.70E-01	1.72E-12	1.65E+05	1.64E-02
15	4.96E-01	1.00E-12	1.37E+05	3.51E-03
16	3.59E-01	2.74E-14	1.54E+05	4.60E-03
17	4.61E-01	3.46E-14	1.44E+05	4.98E-03
18	3.51E-01	2.62E-13	1.63E+05	4.10E-02
19	4.46E-01	6.33E-14	1.26E+05	4.06E-03
20	5.85E-01	1.96E-13	1.44E+05	2.08E-02
21	4.36E-01	1.11E-13	1.21E+05	8.34E-02
22	6.02E-01	1.82E-12	1.29E+05	6.48E-03
23	3.73E-01	1.18E-13	1.67E+05	1.50E-02
24	4.62E-01	3.53E-13	1.50E+05	1.16E-03

25	5.88E-01	1.24E-12	1.33E+05	1.76E-03
26	3.97E-01	1.76E-13	1.48E+05	2.17E-02
27	6.18E-01	4.75E-14	1.53E+05	3.43E-02
28	4.37E-01	2.13E-13	1.42E+05	1.24E-03
29	4.77E-01	4.52E-13	1.47E+05	1.24E-02
30	4.02E-01	2.89E-14	1.39E+05	1.04E-03
31	5.21E-01	1.64E-13	1.55E+05	1.51E-03
32	6.51E-01	1.39E-12	1.62E+05	8.35E-03
33	6.38E-01	7.17E-13	1.35E+05	2.73E-03
34	3.68E-01	5.05E-13	1.58E+05	2.06E-03
35	3.85E-01	8.31E-13	1.29E+05	9.83E-02
36	5.11E-01	1.40E-13	1.59E+05	5.84E-03
37	5.45E-01	8.10E-14	1.27E+05	1.44E-02
38	4.21E-01	2.04E-12	1.34E+05	1.64E-03
39	5.94E-01	4.59E-13	1.70E+05	4.84E-02
40	5.63E-01	7.35E-14	1.22E+05	2.90E-02
41	5.26E-01	2.31E-12	1.43E+05	3.17E-02
42	4.30E-01	6.55E-13	1.26E+05	3.18E-03
43	3.93E-01	1.13E-12	1.35E+05	7.96E-03
44	4.08E-01	1.55E-12	1.69E+05	2.56E-02
45	5.51E-01	2.23E-13	1.45E+05	1.84E-02
46	5.79E-01	5.84E-13	1.21E+05	5.57E-03
47	5.03E-01	9.51E-14	1.61E+05	1.40E-03
48	4.14E-01	1.28E-13	1.68E+05	9.49E-03
49	5.58E-01	3.53E-14	1.41E+05	7.40E-03
50	6.57E-01	3.24E-13	1.56E+05	2.32E-03

### 3.2 DRSPALL Summary Output

The final spillings volumes calculated by DRSPALL for the four scenarios and 50 vectors are listed in Table 3-2. These volumes are based on the 1D spherical flow geometry in the repository, as illustrated in Figure 2-2 except for four cases (2 vectors in scenarios S3 and S4) where cavity radius exceeded repository height. Analysis of individual scenarios and specific vectors are addressed in the discussion that follows.

*Table 3-2. Summary of spillings releases for the 4 scenarios and 50 vectors*

Vector	R1S1	R1S2	R1S3	R1S4
	P=10 MPa	P=12 MPa	P=14 MPa	P=14.8 MPa
	SPLVOL2 (m <sup>3</sup> )	SPLVOL2 (m <sup>3</sup> )	SPLVOL2 (m <sup>3</sup> )	SPLVOL2 (m <sup>3</sup> )
1	0	0	0.3969786	0.5573982
2	0	1.219309	7.218	7.29747
3	0	0	0	0
4	0	0.5647984	1.288459	1.61065
5	0	0	0.07992458	0.2073942
6	0	0	0.07098113	0.1825025
7	0	0	0	0
8	0	0	0	0
9	0	0	0.1893962	0.3403259
10	0	0	0	0
11	0	0	0.2772627	0.3810624
12	0	0	0.04027504	0.09223854
13	0	0	0.1027906	0.2163116
14	0	0	0.03571318	0.137268
15	0	0	0.1126825	0.2696921
16	0	1.708426	3.130843	3.952352
17	0	0	0.09304333	0.3760077
18	0	0	0.6011905	1.170028
19	0	0.607245	4.405089	5.317553
20	0	0.007934533	0.2248029	0.3182866
21	0	0	0	0
22	0	0	0.02612711	0.1082159
23	0	0.1665951	1.788106	2.248536
24	0	0	0.4610163	0.6337715

25	0	0	0.06482388	0.1654469
26	0	0.1392531	1.033008	1.794724
27	0	0	0	0
28	0	0.03465368	0.7382768	1.452345
29	0	0	0.3845654	0.4869126
30	0	7.00046	9.45296	12.062043
31	0	0.09779406	0.6942384	1.427621
32	0	0	0.02364516	0.097811
33	0	0	0.1207344	0.2572754
34	0	0	0.4061748	0.6018938
35	0	0	0.2688929	0.4417713
36	0	0.1828914	0.9488029	1.670775
37	0	0	0	0
38	0	0	0.05156692	0.1609376
39	0	0	0.2100307	0.3452956
40	0	0	0	0
41	0	0	0.009508261	0.0897904
42	0	0	0.3110759	0.5206025
43	0	0	0.1570537	0.3251399
44	0	0	0.06952912	0.1797236
45	0	0	0.4843711	0.6526521
46	0	0	0.2243195	0.4319749
47	0	0.2443149	1.809723	3.105359
48	0	0.2241325	1.336131	2.329654
49	0	0	0	0
50	0	0	0.3235973	0.5460343

### 3.3 Scenario 1 (R1S1) results

Initial repository pressure was set to 10 MPa for scenario 1. The summary data presented in Table 3-2 indicate that no spallings releases are observed for this scenario. This is primarily because the pressure difference between the repository (10 MPa) and the wellbore (hydrostatic pressure of about 7.8 MPa) is not sufficient to cause tensile failure and fluidization of the waste material.

We may confirm that no repository material fails in scenario 1 by examining the history variable BEDDEPTH, which is defined as the depth (m) of failed, bedded material in the cavity that connects the wellbore domain with the repository domain. If no material fails, then bed depth will remain at zero. Figure 3-1 is a “horsetail” plot in which BEDDEPTH is plotted for all 50 vectors in scenario 1. All the data overlay at zero for all times.

Also instructive is the evolution of the cavity radius as a function of time. Since no failure is observed in scenario 1, cavity growth is caused by drilling alone. Figure 3-2 displays the cavity radius as a function of time for all 50 vectors. Drilling starts above the repository domain in the overlying salt, and cavity radius is constant until the bit penetrates the repository at about 34 seconds. The initial cavity radius is set to 0.11 meters in all vectors. This initial radius represents the pseudo-cavity that is formed prior to bit penetration in order to prevent flow to a single point (spherical geometry) or line (cylindrical geometry) in the one-dimensional, radially symmetric domain. See WIPP PA 2003a for details.

Once the bit contacts the repository, the cavity begins to grow due to material removal by the bit. Note that for a 1-D domain, the bit must expand radially to remove material, and the cavity radius will increase as drilling proceeds.

Termination of drilling occurs when the drill penetration rate  $\times$  drilling time = repository height. The array of resultant drilling times and cavity radii seen in Figure 3-2 occur because current repository height ( $H$ ) is a direct function of current waste porosity ( $\phi$ ) and initial waste room height ( $H_o$ ) and porosity ( $\phi_o$ ):

$$H = \frac{(1 - \phi_o)H_o}{1 - \phi} \quad (3.1)$$

and current waste porosity is a sampled parameter, as shown in Table 3-1. The uniformly sampled waste porosities ultimately cause the similarly-distributed final cavity radii in Figure 3-2.

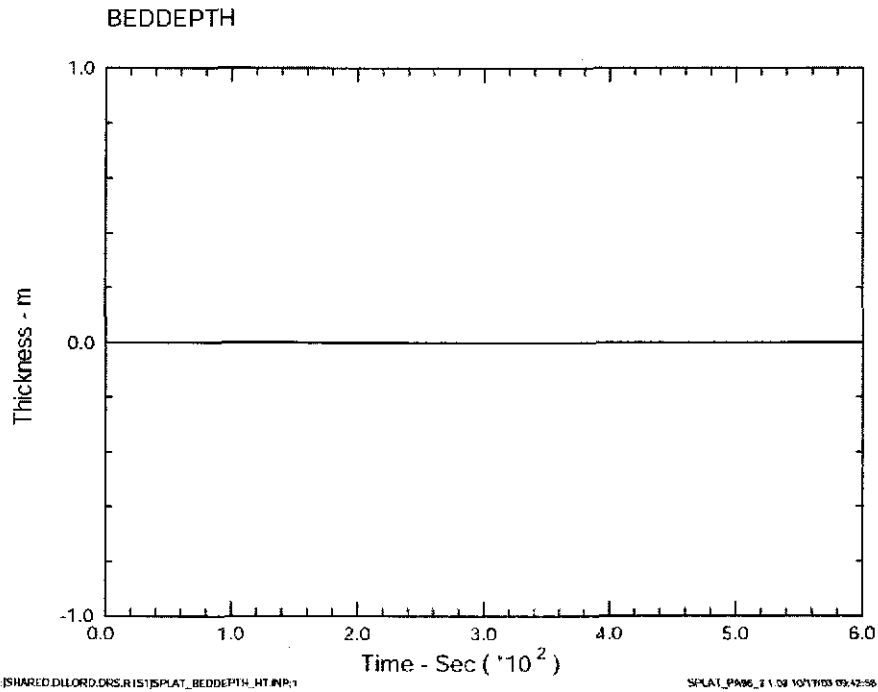

Figure 3-1. Horsetail plot of *BEDDEPTH* for all 50 vectors in Scenario 1. All data overlay at zero.

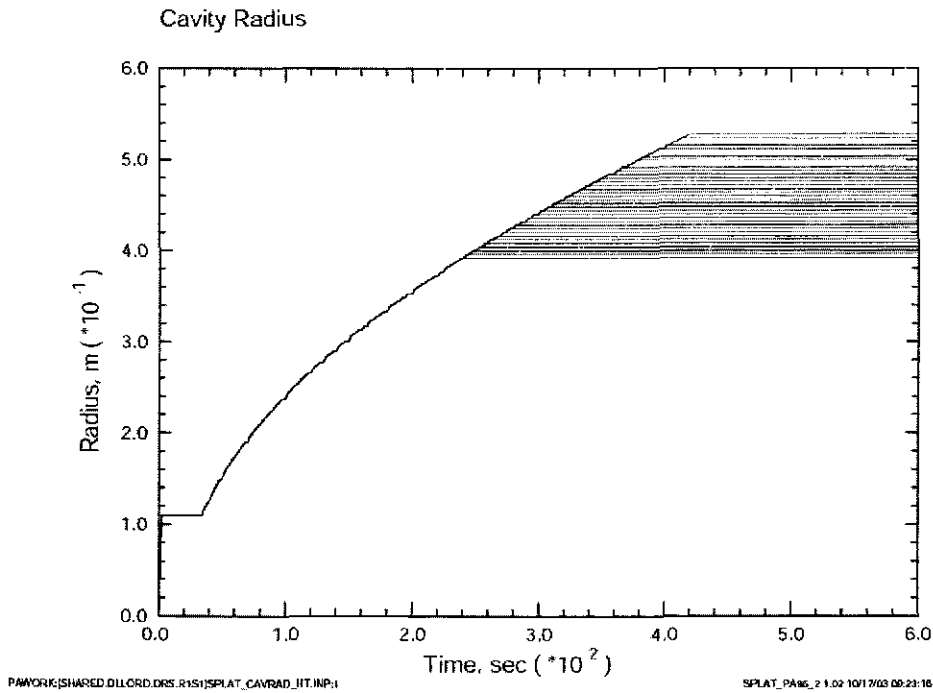

Figure 3-2. Horsetail plot of *CAVRAD* for Scenario 1.

### 3.4 Scenario 2 (R1S2) Results

Initial repository pressure was set to 12 MPa for scenario 2. The summary data presented in Table 3-2 indicate that spillings releases range from 0 to 7 m<sup>3</sup> uncompacted volume. These same data are displayed graphically in the bar graph shown in Figure 3-3. The vectors are sorted in ascending order of release volume. Since each vector is equally probable (1 in 50), the figure also may be interpreted as a cumulative distribution function (CDF). For example, since 47 of the 50 vectors exhibit less than 1 m<sup>3</sup> release, there is a 94% probability that an intrusion at 12 MPa would release less than 1 m<sup>3</sup> of spalled material.

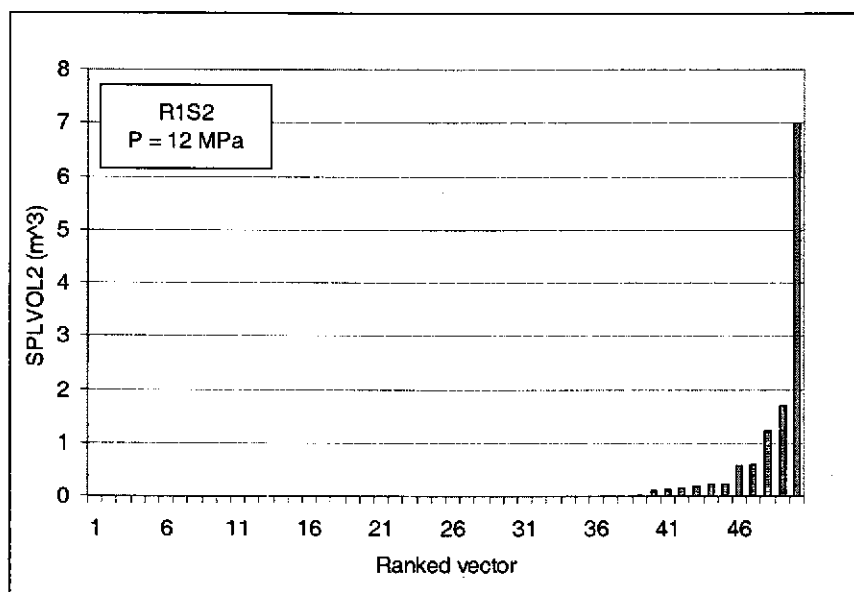

Figure 3-3. Bar graph of SPLVOL2 releases per vector for S2, ranked in ascending order.

#### 3.4.1 R1S2 Cavity Radius

The SPLVOL2 values shown above in Figure 3-3 represent final values obtained after the system reached a steady state. In order to confirm that the system had stabilized, the cavity radius was examined as a function of time in the horsetail plot shown in Figure 3-4. While 49 of the 50 vectors exhibit a steady CAVRAD value by 600 seconds, one vector (v030) is still increasing. It was thus necessary to run v030 out beyond 600 seconds. Figure 3-5 shows the cavity radius, drilled radius, and tensile radius for v030 alone, run out to 1000 seconds, indicating that the cavity radius stabilizes to 0.97 m after 750 seconds. Hence the SPLVOL2 value obtained for v030 was captured at 1000 seconds rather than at 600 seconds for the 49 other vectors in this scenario.

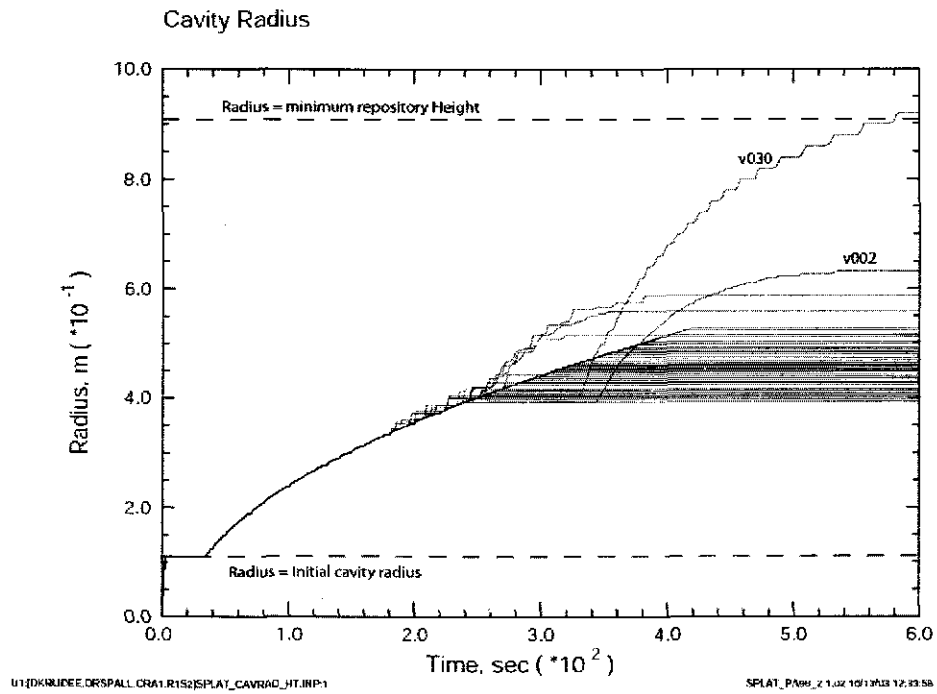

Figure 3-4. Horsetail plot of CAVRAD for scenario 2.

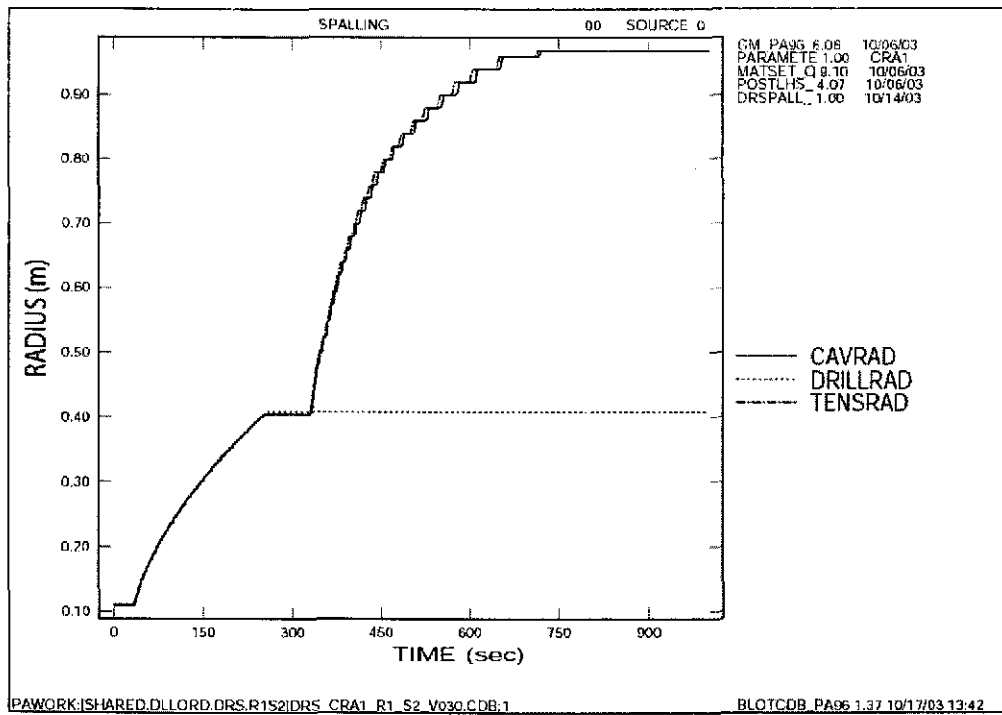

Figure 3-5. History plot of CAVRAD, DRILLRAD, and TENS RAD for RIS2 v030 run out to 1000 seconds.



A re-examination of the input parameters for vector 030 shows that this large release vector had relatively low waste porosity and permeability, as well as the lowest particle diameter in its sampled range. Once failed, the particulate solid waste was easily fluidized. This feature is confirmed by examining the plot of the waste boundary superficial velocity (WBSUPVEL) and the minimum fluidization velocity (FLUIDVEL) shown in Figure 3-6. When  $WBSUPVEL > FLUIDVEL$ , as it is for the entire duration plotted in Figure 3-6, failed waste will readily fluidize and transport up the borehole.

The individual spikes in the WBSUPVEL curve in Figure 3-6 occur when individual zones are removed from the repository domain via failure and fluidization. The small spikes that occur between 50 and 300 seconds are due to drilling in the repository. The spikes beyond 300 seconds result from fluidization of recently failed zones.

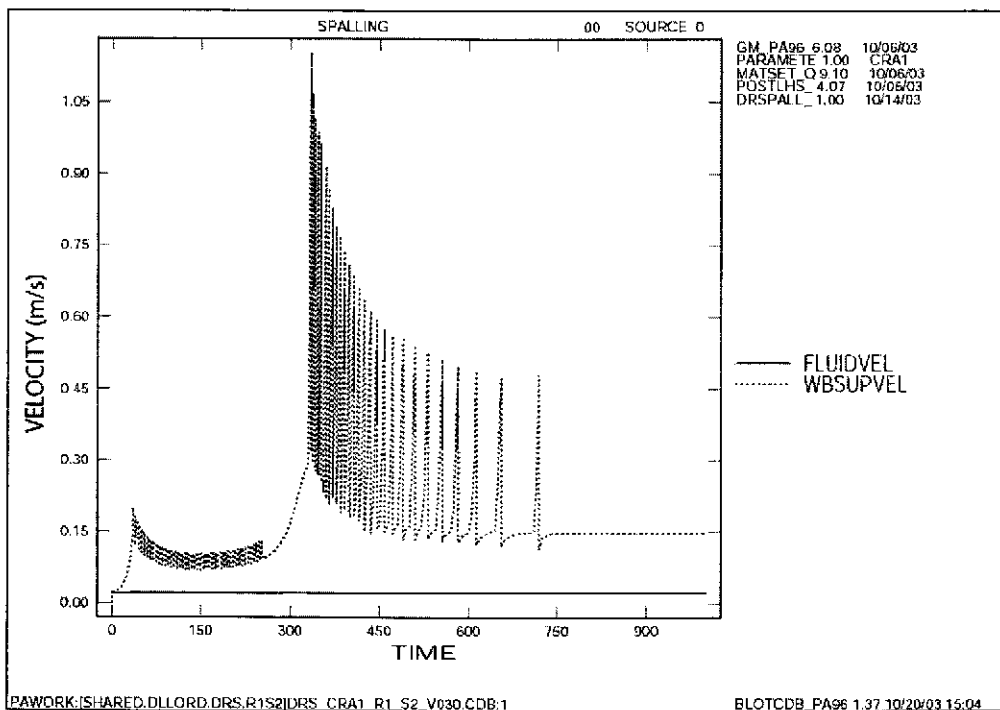

Figure 3-6. History plot of waste boundary superficial velocity (WBSUPVEL) and minimum fluidization velocity (FLUIDVEL) for S2, v030.

### 3.4.2 RIS2 v030 Radial Effective Stress

Since all bedded material will fluidize in v030, the cavity growth must be tensile failure-limited. In order to visualize the stress state in the solid that leads to stabilization of the cavity, the radial effective stress (RADEFSTR) is plotted at a selected time, 750 sec, in Figure 3-7. The current cavity wall, marked in the figure, is located at 0.967 m from the origin. The x-axis “distance” in Figure 3-7 is given from a reference point in the cavity. Negative stress values indicate tension, while positive stress values indicate compression. The horizontal line of constant stress from DISTANCE = 0 to the cavity wall indicates failed, fluidized material, and is arbitrarily set to the tensile strength ( $T_s = 1.39\text{E}+05$  Pa) of the solid. The grid in DRSPALL is zone-centered, so the cavity wall falls halfway between the last grid point in the cavity and the first grid point in the waste. Radial effective stress at the cavity wall is zero by definition (Eqs 2.2-2.4). Since there is no grid point exactly at the cavity wall, however, the plot below does not show an exact zero value. The “line” in Figure 3-7 that connects discrete points is simply added by the plotting utility and is not used in DRSPALL calculations.

From the cavity wall outward, the radial effective stress decreases to a minimum near  $-1.75\text{E}+05$  Pa tension at about 0.02 m from the cavity wall. Moving further outward beyond the minimum, RADEFSTRS climbs into a compressive state ( $>0$ ). This plot demonstrates that tensile failure does not occur at the cavity wall at runtime = 750 seconds because the mean radial effective stress in tension over the characteristic length  $L_t$  does not exceed the tensile strength. Table 3-3 computes the average RADEFSTR over  $L_t$  explicitly. Reviewing the calculation, the cavity wall starts with DRSPALL coordinate 0.9691m. One characteristic length includes five zones, identified by the bold border in the table. The mean RADEFSTR for these five zones is  $-1.3461\text{E}+05$  Pa, which is not sufficient to fail the waste with  $T_s = 1.39\text{E}+05$  Pa

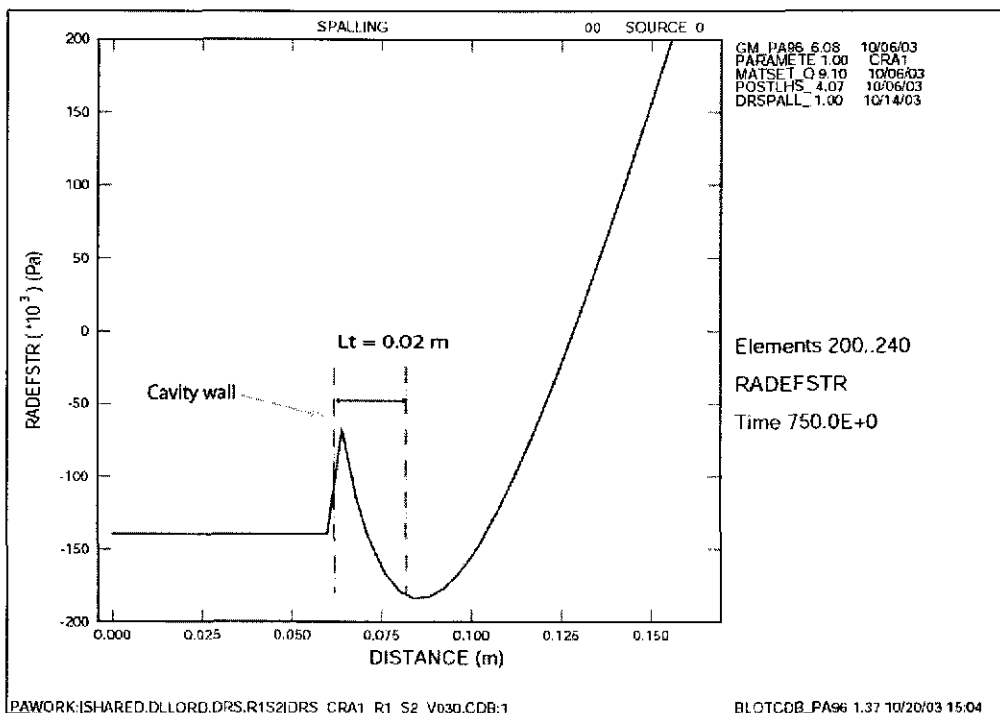

Figure 3-7. Spatial plot of radial effective stress (RADEFSTR) near cavity wall for v030 at runtime = 750 seconds.

Table 3-3. Calculation of mean RADEFSTR over  $L_t$  for S2, v030 at runtime = 750 sec.

DRSPALL COORD	Plot Coordinate	RADEFSTR	Average RADEFSTR over $L_t$
0.9611	0.0560	-1.3930E+05	
0.9651	0.0600	-1.3930E+05	
0.9691	0.0640	-6.7352E+04	
0.9731	0.0680	-1.1412E+05	
0.9771	0.0720	-1.4607E+05	-1.3461E+05
0.9811	0.0760	-1.6679E+05	
0.9851	0.0800	-1.7873E+05	
0.9891	0.0840	-1.8363E+05	
0.9931	0.0880	-1.8278E+05	

**3.4.3 Scenario 2 Scatter plots**

Scatter plots are used here to examine model sensitivity to the sampled input variables waste porosity, waste permeability, waste tensile strength, and waste particle diameter. SPLVOL2 values are plotted against each input variable on a vector-by-vector basis to identify any important relationships. Shown in Figure 3-8 are four scatter plots for the scenario 2 runs. The independent variable values on the x-axes correspond to the values obtained in the LHS sampling listed in Table 3-1, while the SPLVOL2 values correspond to those listed in Table 3-2.

According to Figure 3-8, the majority of nonzero spallings releases appear to correlate with low waste porosity, low waste permeability, and small particle diameter. The relationship with tensile strength is less definitive. These correlations are reasonable. Low waste permeability will lead to larger tensile stresses and more tensile failure of the waste due to higher pressure gradients near the borehole, though low permeability also leads to low gas velocity which can prevent fluidization of failed wastes. Low waste porosity and particle diameter tend to promote fluidization of failed particles, so the higher frequency of nonzero SPLVOL2 releases when these values are low is consistent with expectations.

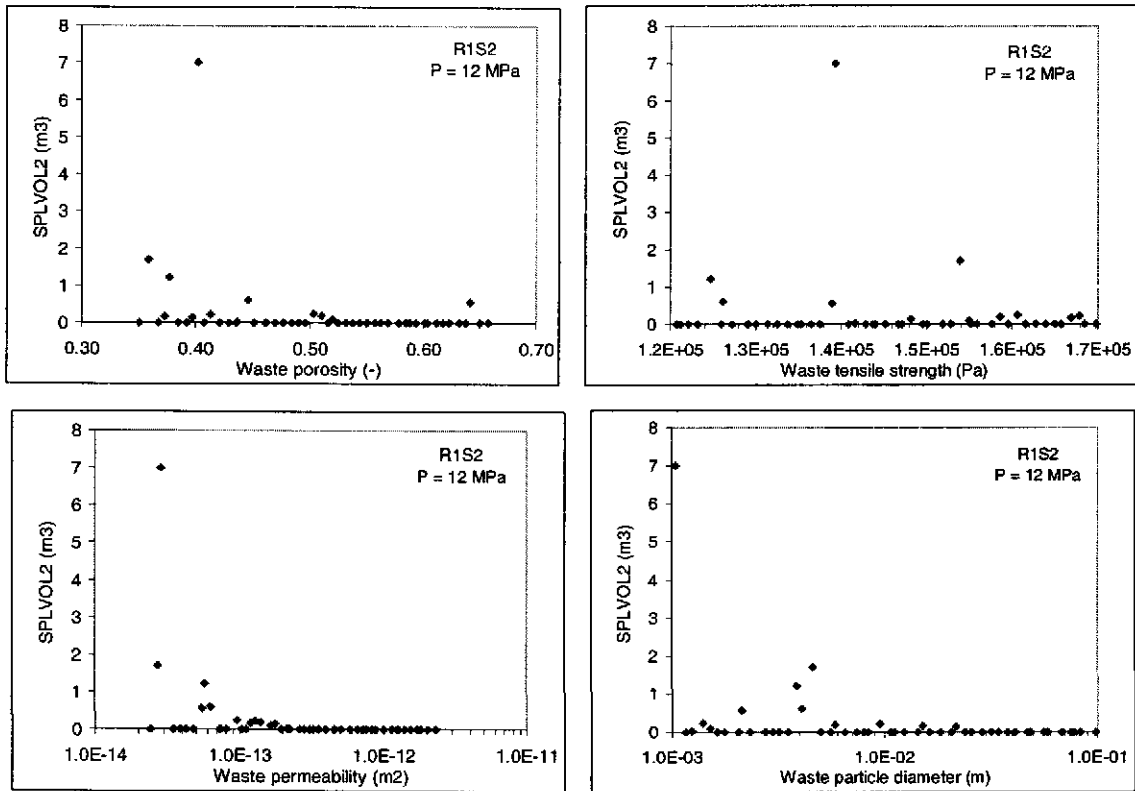

Figure 3-8. Scatter plots of SPLVOL2 versus the sampled waste properties of porosity, tensile strength, permeability, and particle diameter for scenario 2.

### 3.5 Scenario 3 (R1S3) results

Initial repository pressure was set to 14 MPa for scenario 3. The summary data presented in Table 3-2 indicate that spallings releases range from 0 to 9.5 m<sup>3</sup> uncompacted volume. These same data are displayed graphically in the bar graph shown in Figure 3-9. Relative to scenario 2, these release volumes are larger, an expected result of higher initial repository pressure leading to higher tensile stresses and gas velocities.

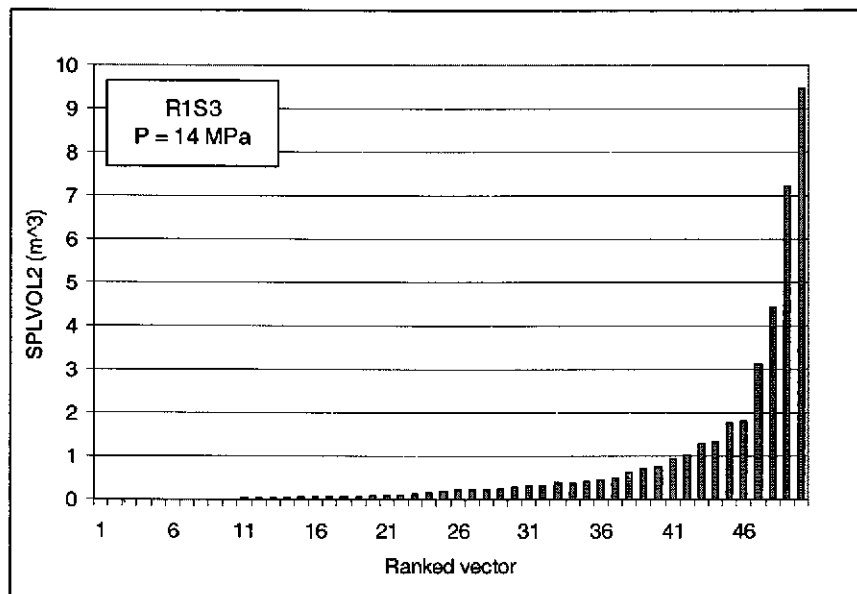

Figure 3-9. Bar graph of SPLVOL2 releases per vector for scenario 3, ranked in ascending order.

#### 3.5.1 Scenario 3 history plots

Figure 3-10 shows the horsetail plot of CAVRAD for scenario 3. Cavity growth ahead of drilling begins between 100 and 150 seconds and stabilizes by 300 seconds in most vectors. The cavity radius of two vectors, v002 and v030, has not stabilized by 600 seconds, therefore requiring additional analysis.

The magnitude of the cavity radius in vectors 002 and 030 nears or exceeds the height<sup>1</sup> of the repository by 600 seconds. This implies that if the cavity formed by spallings is indeed a radially symmetric hemisphere, the cavity would intersect with the Disturbed Rock Zone (DRZ) below the repository, as depicted in the schematic shown in Figure 3-11. Important to note here is that the unsteady porous flow and stress equations that describe the repository in hemispherical geometry do not address the presence of the lower DRZ. Therefore, radial fluid flow, stress distributions, failure, and cavity growth will all proceed regardless of whether the cavity radius has intersected the lower DRZ.

<sup>1</sup> Heights of repository for v002 and v030 are  $H_{v002} = 0.954063$  m, and  $H_{v030} = 0.993311$  m.

While this conservative assumption is useful in simplifying the calculations, and furthermore a fair representation of the relevant problem geometry early in penetration, its applicability breaks down as the cavity radius approaches the repository height. Release volumes are certainly overestimated when  $CAVRAD \rightarrow H$  as some of the cavity volume originates from the DRZ, which has very different properties from the WIPP waste. To address this issue, DRSPALL is also exercised in cylindrical geometry for vectors 002 and 030 in order to better understand the flow, stress, and cavity growth properties, and form a defensible upper bound for the cavity size and release volumes.

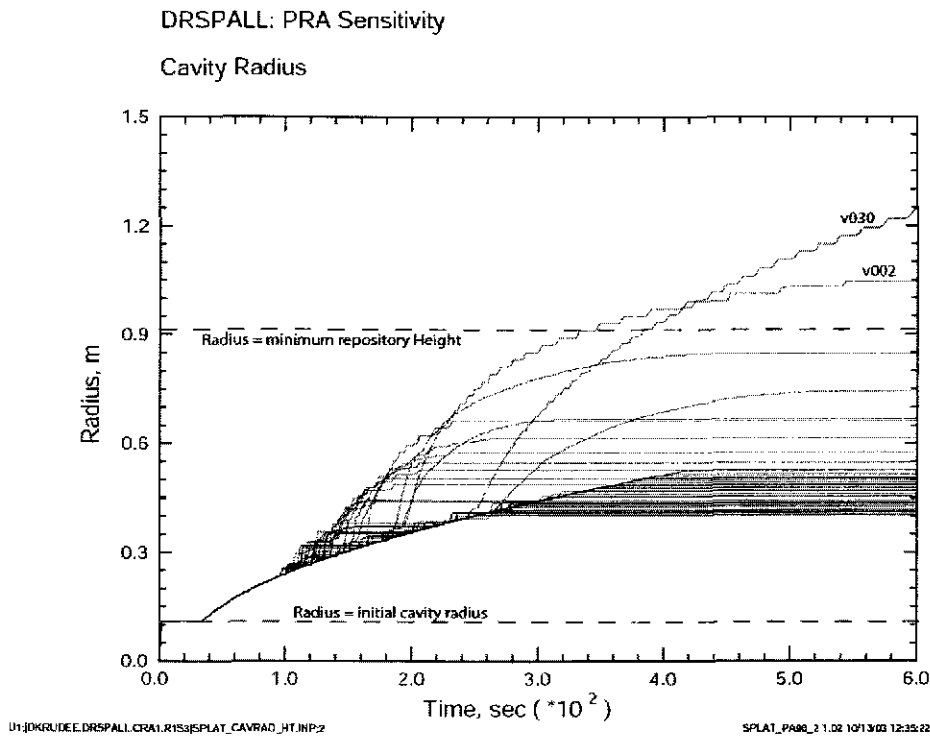

Figure 3-10. Horsetail plot of CAVRAD for scenario 3

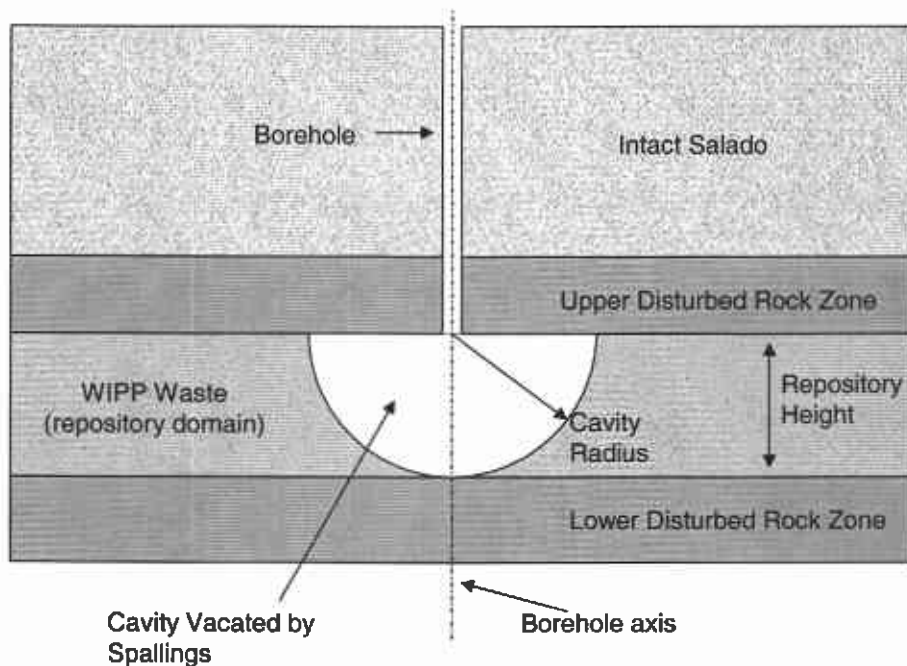

Figure 3-11. Schematic of hemispherical spallings cavity intersecting the lower DRZ.

#### 3.5.1.1 Special cylindrical runs, v002 & v030

Vectors 002 and 030 were re-run in cylindrical geometry, with the initial cavity radius set equal to their respective repository heights. DRSPALL is configured to start with an arbitrary cavity radius, though in normal runs the initial cavity radius is defined by the pseudo-cavity<sup>2</sup> assumption. The special cylindrical runs started with a large, gas-filled cylindrical cavity at REPIPRES = 14 MPa, connected to the surface by a mud-filled borehole. The DRSPALL code version 1.00 does not have the capability to start with an arbitrary pressure profile in the repository that resembles the profile observed as CAVRAD  $\rightarrow H$  in the spherical runs. Therefore, a uniform pressure distribution and mud-filled column is used for the initial conditions that would be present at the end of the run in spherical geometry.

Figure 3-12 shows the history plot of CAVRAD for the v002 and v030 cylindrical runs. Cavity radius starts at the specified input values of 0.95 (v002) and 0.99 m (v030). For v002, no more cavity growth is observed. For v030, the cavity expands slightly to a stable value of 1.06 m

<sup>2</sup> See §3.3 and the *Design Document for DRSPALL, document version 1.10* (WIPP PA, 2003a).

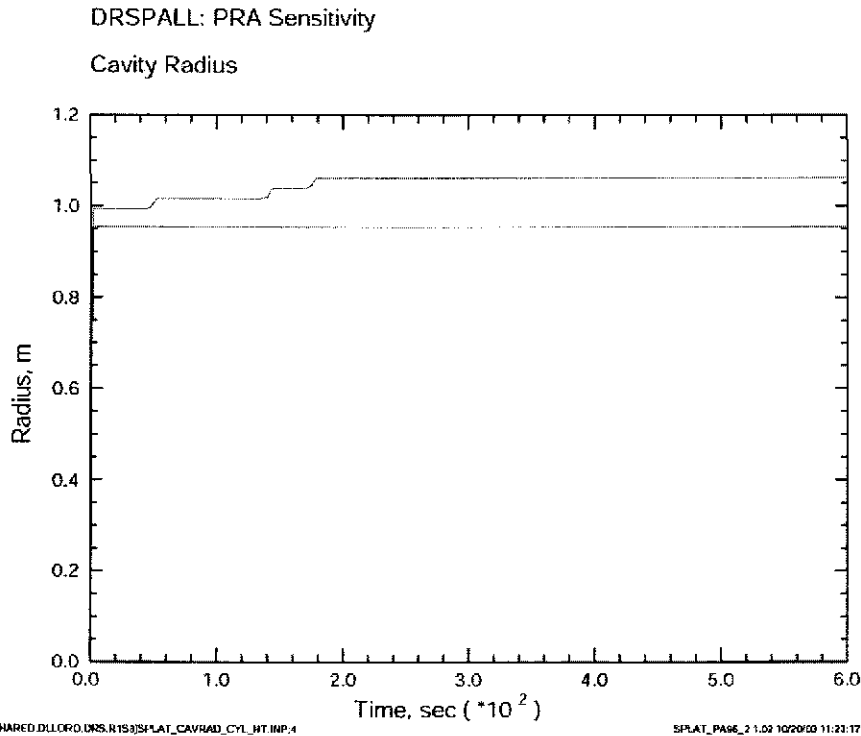

Figure 3-12. Horsetail plot of CAVRAD for v002 and v030, cylindrical geometry, scenario 3.

### 3.5.2 Scenario 3 radial effective stress

A closer look at the stress and fluidization parameters is required to determine what mechanisms ultimately stabilize the cavity in v002 and v030. For v002, the radial effective stress profile is plotted at  $t = 140$  seconds in Figure 3-13. Recall that the tensile strength for v002 is  $T_s = 1.25E+05$  Pa, which falls well below the given RADEFSTR profile. Similar profiles at earlier and later times were examined (not shown) and  $t = 140$  second represents the largest tensile stresses observed. Thus, the stresses in this configuration are not sufficient to cause more failure and the system is failure-limited.

For v030, a similar strategy was used, and the largest tensile stresses near the cavity wall were observed near  $t = 200$  seconds (see Figure 3-14). In this case, stresses 1 to 11 cm interior to the cavity wall exceed the tensile strength, but fall beyond the characteristic length, and thus do not fail the solid. Again, this vector is failure-limited. The mean RADEFSTR over  $L_t$  is computed explicitly in Table 3-4.



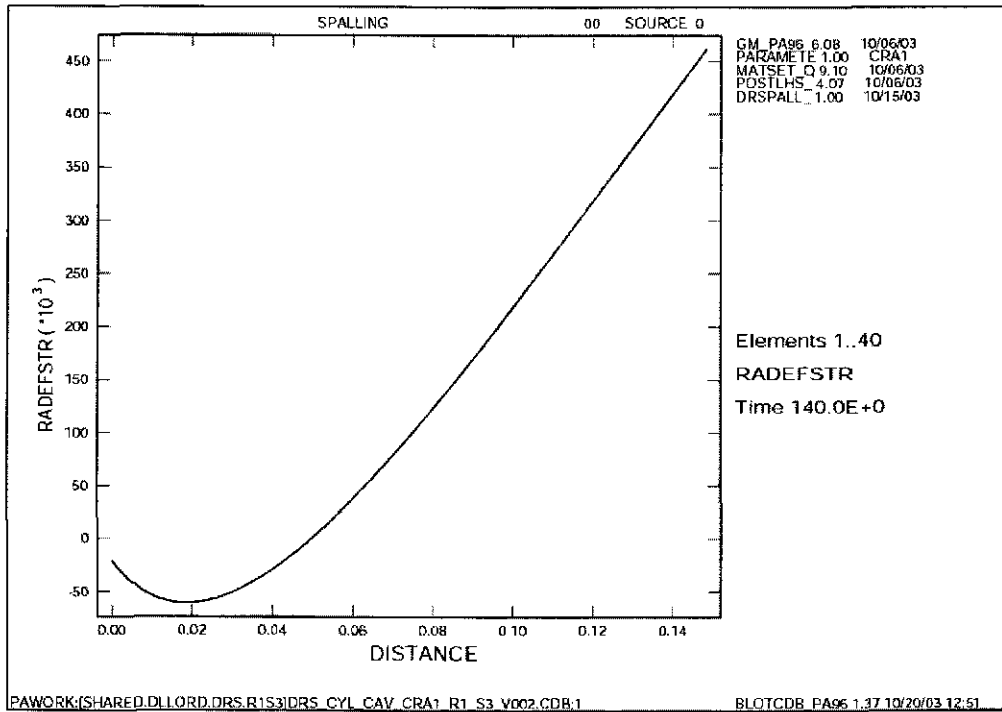

Figure 3-13. Spatial plot of radial effective stress (RADEFSTR) near cavity wall for v002 in cylindrical geometry,  $T_S = 1.25E+05$  Pa.

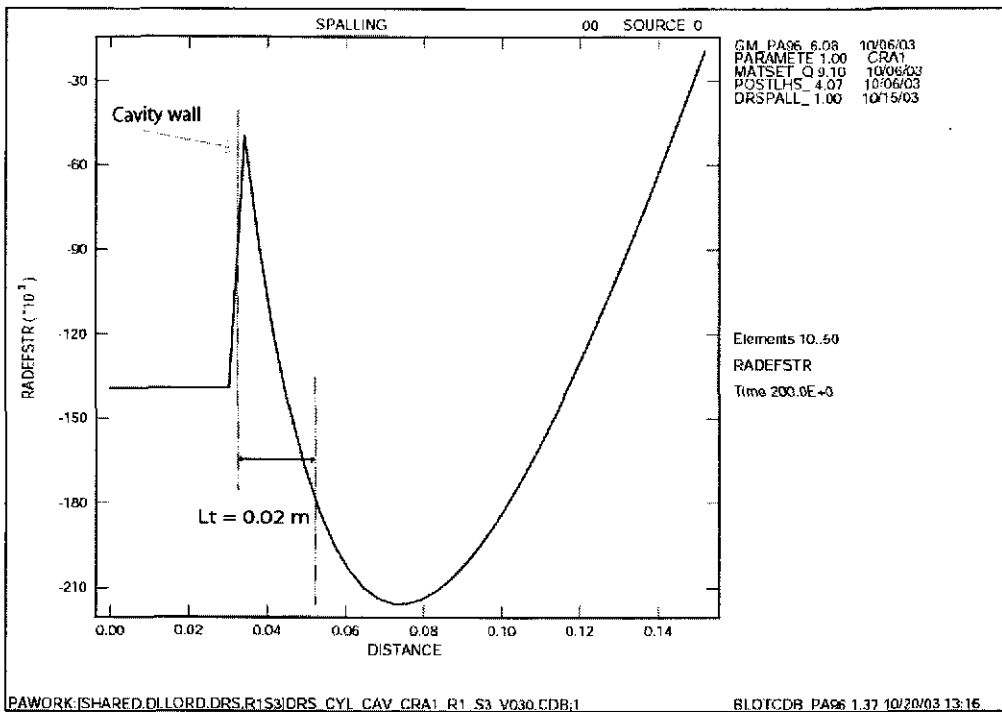

Figure 3-14. Spatial plot of radial effective stress (RADEFSTR) near cavity wall for v030 at 200 sec in cylindrical geometry,  $T_S = 1.39E+05$  Pa.

Table 3-4. Calculation of mean RADEFSTR over  $L_t$  for S3, v030 at runtime = 200 sec in cylindrical geometry.

DRSPALL COORD	Plot Coordinate	RADEFSTR	Average RADEFSTR over $L_t$
1.0559	0.0266	-1.3930E+05	
1.0597	0.0303	-1.3930E+05	
1.0635	0.0341	-4.9744E+04	
1.0673	0.0379	-8.9325E+04	
1.0711	0.0417	-1.2101E+05	-1.1460E+05
1.0749	0.0455	-1.4637E+05	
1.0787	0.0493	-1.6654E+05	
1.0825	0.0531	-1.8237E+05	
1.0862	0.0569	-1.9453E+05	

### 3.5.3 Final SPLVOL2 volumes for RIS3

Constructing the table of final releases (Table 3-2) for scenario 3 required merging the SPLVOL2 data from the spherical runs and the two special cylindrical runs. For the 48 vectors that stabilized in spherical geometry, the final SPLVOL2 value was simply extracted from the corresponding CDB output file at a runtime of 600 seconds. For v002 and v030, the final release was the sum of SPLVOL2 from the spherical geometry when CAVRAD = H, and SPLVOL2 calculated from the cylindrical run at runtime = 600 seconds. The procedure is demonstrated below.

#### 3.5.3.1 Example calculation of SPLVOL2 (v002 and v030)

The GROPECDB utility (WIPP PA, 1996b) is used to find the SPLVOL2 value that corresponds to the point when CAVRAD = H. First, the value for repository height H is retrieved from the CDB (variable name REPOSTCK), with  $H = 9.93311\text{E-}01$  m for v030. Second, a listing of the data line number, runtime, SPLVOL2, and CAVRAD values is produced in order to find the point at which  $\text{CAVRAD} \geq H$ . An excerpt from the ASCII output listing for v030 is given below in Table 3-5. The point where  $\text{CAVRAD} \geq 9.93311\text{E-}01$  gives  $\text{SPLVOL2} = 7.70755\text{E+}00$  (highlighted in table). A similar procedure for v002 yields  $\text{SPLVOL2} = 7.21800\text{E+}00$ . Recall that SPLVOL2 is equivalent uncompact volume and is much greater than the volume enclosed by the cavity radius, CAVRAD. Also, the enclosed volume includes cuttings volume, where as SPLVOL2 does not.

*Table 3-5. Excerpt from GROPECDB output file analyzing RIS3, v030 for the point when CAVRAD  $\geq H$  (highlighted).*

STEP	TIME (sec)	CAVRAD (m)	SPLVOL2 (m <sup>3</sup> )
315	4.23E+02	9.79097E-01	7.31703E+00
316	4.23E+02	9.83097E-01	7.41347E+00
317	4.24E+02	9.87098E-01	7.51070E+00
318	4.24E+02	9.91098E-01	7.60873E+00
319	4.25E+02	9.95098E-01	7.70755E+00
320	4.25E+02	9.95098E-01	7.70755E+00
321	4.30E+02	9.95098E-01	7.70755E+00
322	4.34E+02	9.99098E-01	7.80716E+00
323	4.35E+02	1.00310E+00	7.90758E+00

SPLVOL2 values are then retrieved from the cylindrical run CDB output using the standard WIPP PA SUMMARIZE (WIPP PA, 1996a) utility, with the results given in Table 3-6.

*Table 3-6. SPLVOL2 values at 600 seconds for the special cylindrical runs.*

VECTOR	TIME	SPLVOL2
v002	6.00E+02	0.00000E+00
v030	6.00E+02	1.74541E+00

The final SPLVOL2 values are then taken as the sum of the spherical and cylindrical releases (across a row) as shown in Table 3-7. The WIPP utility SUMMARIZE is used to build the draft version of the ASCII table of final spillings volumes that is passed to CUTTINGS\_S, though this draft does not have the updated final volumes from Table 3-7 for v002 and v030. These values are substituted manually to create a final version ready for transfer to CUTTINGS\_S. A listing of this file is given in Appendix SPALL\_TABLE.

*Table 3-7. Summary of final releases for v002 and v030, RIS3 and RIS4. Units are m<sup>3</sup> uncompactd spall volume.*

<b>Scenario</b>	<b>Vector</b>	<b>SPLVOL2 (SPH)</b>	<b>SPLVOL2 (CYL)</b>	<b>SPLVOL2 (FINAL)</b>
<b>RIS3</b>	v002	7.21800E+00	0.00000E+00	7.21800E+00
	v030	7.70755E+00	1.74541E+00	9.45296E+00
<b>RIS4</b>	v002	7.29747E+00	0.00000E+00	7.29747E+00
	v030	7.80900E+00	4.25304E+00	1.20620E+01

### 3.6 Scenario 4 (R1S4) results

Initial repository pressure was set to 14.8 MPa for scenario 4. The summary data presented in Table 3-2 indicate that spallings releases range from 0 to 12.1 m<sup>3</sup> uncompacted volume. These same data are displayed graphically in the bar graph shown in Figure 3-15. Relative to the other three scenarios, these releases are larger, an expected result of higher initial repository pressure leading to higher tensile stresses and gas velocities.

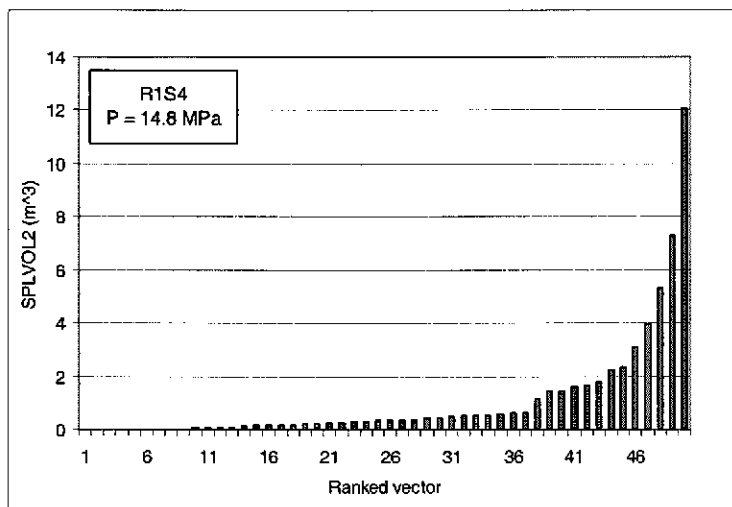

Figure 3-15. Bar graph of SPLVOL2 releases per vector for scenario 4, ranked in ascending order.

#### 3.6.1 Scenario 4 history plots

Figure 3-16 shows the horsetail plot of CAVRAD for scenario 4. Cavity growth ahead of drilling begins between 100 and 150 seconds and stabilizes by 500 seconds in most vectors. The cavity radius of two vectors, v002 and 030, has not stabilized by 600 seconds, therefore requiring additional analysis.

#### 3.6.2 Special cylindrical runs, v002 & v030

Using the same procedure as described for scenario 3, v002 and 030 were re-run using the cylindrical geometry and a starting CAVRAD =  $H$ . Histories for the cylindrical runs are shown in Figure 3-17. v002 did not fail any further, while v030 failed out to CAVRAD = 1.15m where it then stabilized.

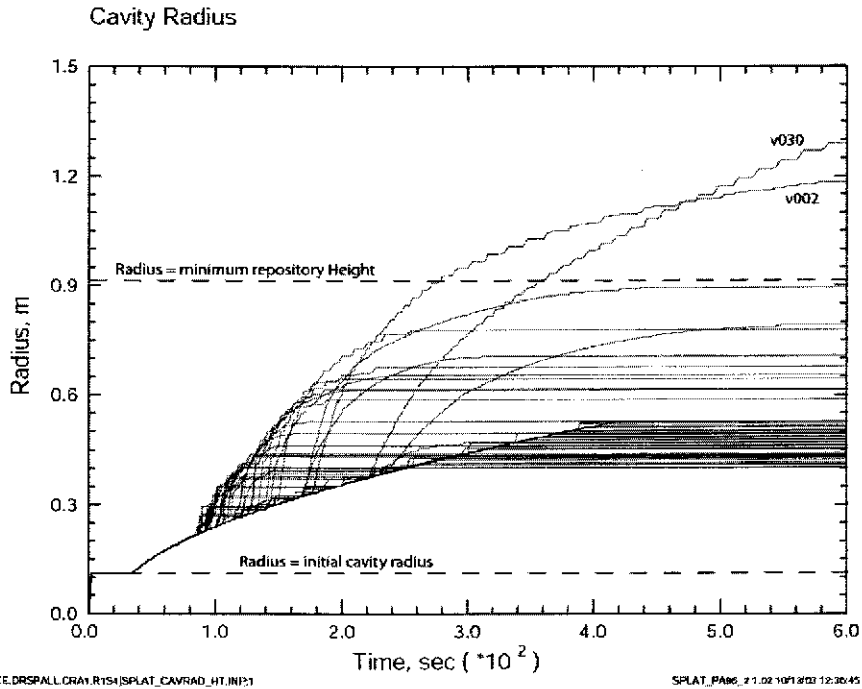

Figure 3-16. Horsetail plot of CAVRAD for scenario 4.

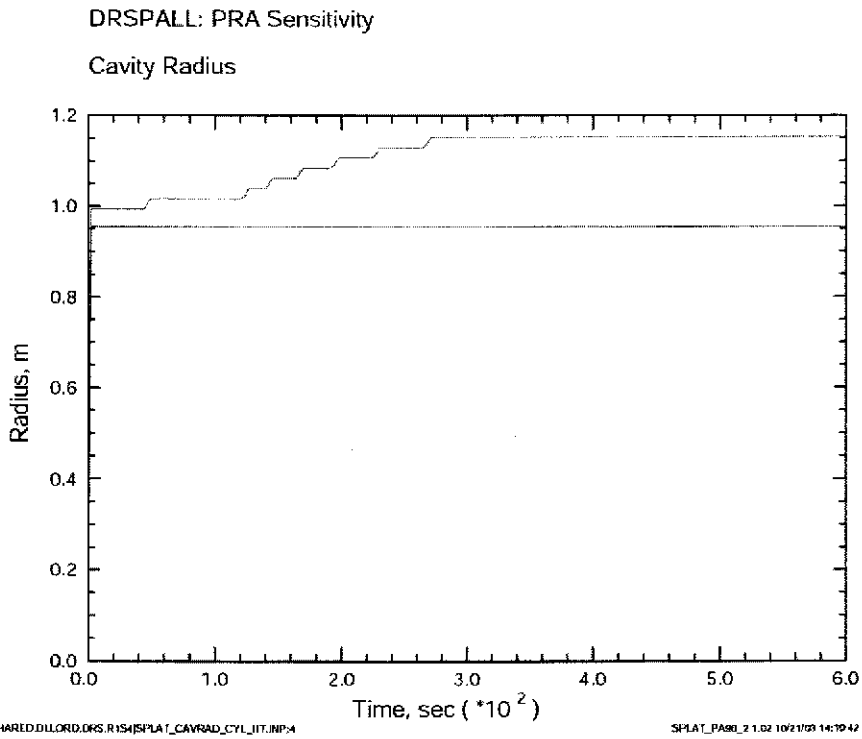

Figure 3-17. History plot of CAVRAD for v002 and v030, cylindrical geometry, scenario 4.

3.6.3 Scenario 4 scatter plots

Scatter plots for scenario 4 are shown in Figure 3-18, illustrating final SPLVOL2 values as a function of the four sampled input variables. Larger releases appear to correlate with low waste porosity, low waste permeability, and small particle diameter. No particular correlation is evident with tensile strength, though the sampling range is smaller for this variable than any of the other three. These observations are consistent with those from scenario 2, discussed in Section 3.4.3.

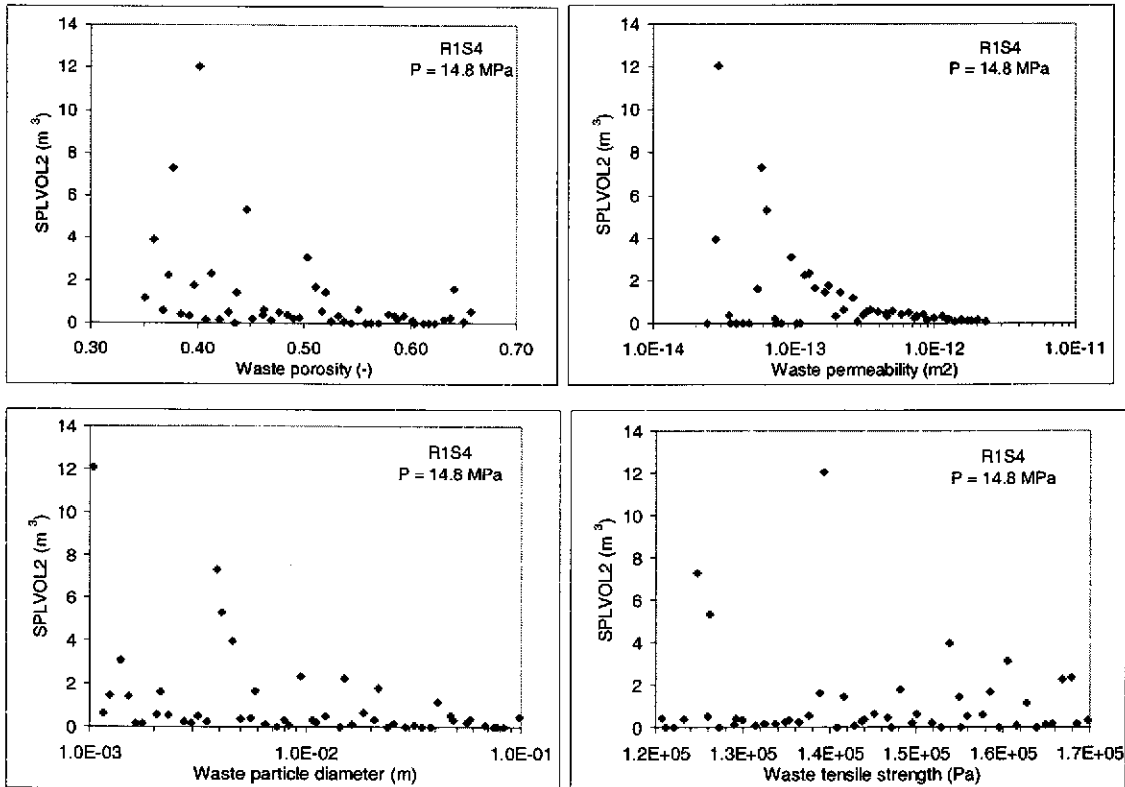

Figure 3-18. Scatter plots of SPLVOL2 versus sampled waste properties for porosity, permeability, tensile strength and particle diameter for scenario 4.

#### 4 SUMMARY

The newly-developed spallings code, DRSPALL, was used to calculate spallings releases for the 2004 WIPP CRA. These data were compiled into a table that is read by the WIPP PA code CUTTINGS\_S for incorporation into the Total System Performance Assessment. The matrix of DRSPALL runs comprised four scenarios and fifty vectors for a total of 200 calculated release values. Each scenario was assigned an initial repository pressure. Each vector comprised an equally probable unique set of input variables that is selected by LHS sampling.

The summary of releases is compiled here into a 3-D bar chart, and also presented earlier in Table 3-2. Uncompacted spallings volumes are displayed in Figure 4-1 as a function of scenario and vector number, sorted by ascending SPLVOL2 release in the S4 scenario. Releases are shown to range from 0 to 12.1 m<sup>3</sup>, with the most probable release volume SPLVOL2 = 0 m<sup>3</sup> over the entire parameter space explored. Relative to the prior WIPP spallings model for the PAVT (MacKinnon and Freeze, 1997), which imposed a uniform distribution for releases from 0.5 to 4.0 m<sup>3</sup> for any intrusion in which the repository pressure exceeded 8.0 MPa, the DRSPALL releases are generally lower in magnitude. An exception to this lies in a few vectors at high pressure in which the coupling of several key parameters including waste permeability, porosity, and particle size, allow DRSPALL releases to reach a maximum of 12.1 m<sup>3</sup>.

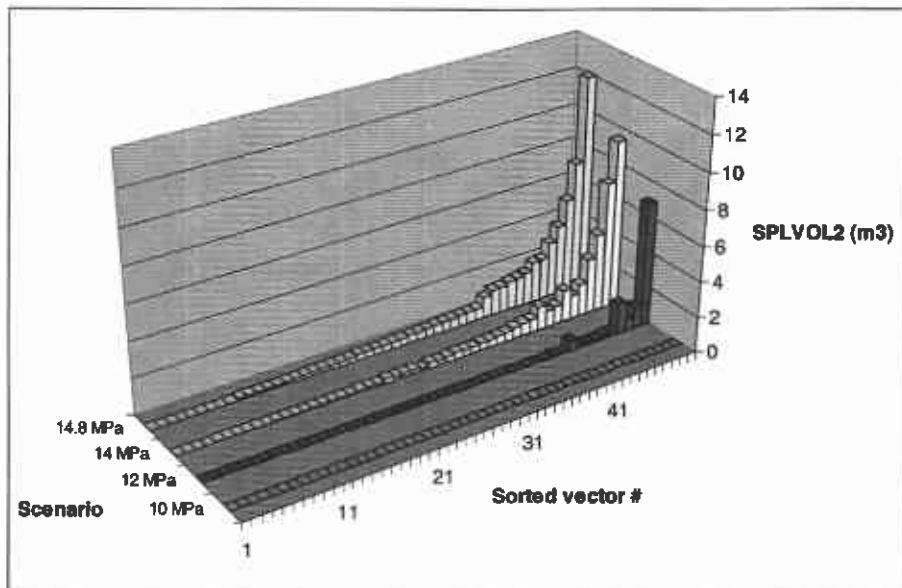

Figure 4-1. 3-dimensional bar chart of spallings releases calculated by DRSPALL for the 2004 WIPP CRA.



## 5 REFERENCES

- DOE (U.S. Department of Energy). 1996. *Title 40 CFR Part 191 Compliance Certification Application for the Waste Isolation Pilot Plant*. DOE/CAO-1996-2184. Carlsbad, NM: United States Department of Energy, Waste Isolation Pilot Plant, Carlsbad Area Office. Vols I-XXI.
- Ergun, S. 1952. "Fluid Flow Through Packed Columns," *Chemical Engineering Progress*, 48:89-94.
- Hansen, F.D., Pfeifle, T.W., Lord, D.L. 2003. *Parameter Justification Report for DRSPALL*. ERMS# 531057. Carlsbad, NM: Sandia National Laboratories.
- Lord, D.L. 2002. *AP-096: Analysis Plan for Completion of the Spallings Model for WIPP Recertification*. ERMS# 524993. Carlsbad, NM: Sandia National Laboratories.
- Lord, D.L., Rudeen, D.K. 2003. *Sensitivity Analysis Report - Parts I & II, DRSPALL version 1.00*. Report for Conceptual Model Peer Review Panel Convening July 7-11, 2003. Records Package ERMS# 524400. Carlsbad, NM: Sandia National Laboratories.
- MacKinnon, R., Freeze, G. 1997. *Summary of EPA-Mandated Performance Assessment Verification Test (Replicate 1) and Comparison with the Compliance Certification Application Calculations*. ERMS# 422595. Carlsbad, NM: Sandia National Laboratories.
- WIPP PA. 1996a. "User's Manual for SUMMARIZE Version 2.10." Sandia National Laboratories. Sandia WIPP Central Files WPO #37460.
- WIPP PA. 1996b. "User's Manual for GROPECDB Version 2.12." Sandia National Laboratories. Sandia WIPP Central Files WPO # 37496.
- WIPP PA, 2002. *Software Quality Assurance Plan for DRSPALL Version 1.00, document version 1.00*. ERMS# 524776. Carlsbad, NM: Sandia National Laboratories.
- WIPP PA, 2003. *Design Document for BRAGFLO Version 5.0, document version 5.00*. ERMS# 525702. Carlsbad, NM: Sandia National Laboratories.
- WIPP PA, 2003a. *Design Document for DRSPALL Version 1.00, document version 1.10*. ERMS# 529878. Carlsbad, NM: Sandia National Laboratories.
- WIPP PA, 2003b. *Installation and Checkout for DRSPALL Version 1.00, document version 1.00*. ERMS# 524783. Carlsbad, NM: Sandia National Laboratories.
- WIPP PA, 2003c. *Requirements Document for DRSPALL Version 1.00, document version 1.20*. ERMS# 524777. Carlsbad, NM: Sandia National Laboratories.
- WIPP PA, 2003d. *User's Manual for DRSPALL Version 1.00, document version 1.10*. ERMS# 524780. Carlsbad, NM: Sandia National Laboratories.
- WIPP PA, 2003e. *Verification and Validation Plan / Validation Document for DRSPALL Version 1.00, document version 1.00*. ERMS# 524782. Carlsbad, NM: Sandia National Laboratories.

Yew, C., Hanson, J., Teufel, L. 2003. *Waste Isolation Pilot Plant Spallings Conceptual Model Peer Review Report*. ERMS# 532520 Carlsbad, NM: Sandia National Laboratories.

**APPENDIX LHS2\_DRSPALL.TRN**

The following is a listing of the LHS output file LHS2\_DRS\_CRA1\_TRN\_A1.OUT fetched from CMS library LIBCRA1\_DRS. The LHS run that creates this file also built 50 output binary files (1 per vector) that are not listed here. Note that the sampled parameter names, distributions, and ranges are given on the first page of this listing. Below this appears a table of the new parameter values computed by LHS, followed by a similar table showing the rank of a particular value within the distribution of 50 values. Rank = 1 corresponds to the lowest value in the distribution, while rank = 50 corresponds to the highest value. The final collection of tables show the histograms for each sampled variable.

1

TITLE SDB: PARAMETER\_PROD      Calc: CRA1              Ver: 1.00              10/06/03 16:10:50

RANDOM SEED =    921196800

NUMBER OF VARIABLES =    4

NUMBER OF OBSERVATIONS =    50

0 THE SAMPLE INPUT VECTORS WILL BE PRINTED ALONG WITH THEIR CORRESPONDING RANKS

0 HISTOGRAMS OF THE ACTUAL SAMPLE WILL BE PLOTTED FOR EACH INPUT VARIABLE

0 THE CORRELATION MATRICES (RAW DATA AND RANK CORRELATIONS) WILL BE PRINTED

1

TITLE SDB: PARAMETER\_PROD      Calc: CRA1              Ver: 1.00              10/06/03 16:10:50

	VARIABLE	DISTRIBUTION	RANGE		LABEL		
0	1	UNIFORM	0.3500	TO	0.6600	SPALLMOD	REPIPOR
0	2	LOGUNIFORM	2.4000E-14	TO	2.4000E-12	SPALLMOD	REPIPERM
0	3	UNIFORM	1.2000E+05	TO	1.7000E+05	SPALLMOD	TENSLSTR
0	4	LOGUNIFORM	1.0000E-03	TO	0.1000	SPALLMOD	PARTDIAM

1TITLE SDB: PARAMETER\_PROD      Calc: CRA1              Ver: 1.00              10/06/03 16:10:50

0LATIN HYPERCUBE SAMPLE INPUT VECTORS

RUN NO.	X(1)	X(2)	X(3)	X(4)	
0	1	5.166E-01	3.966E-13	1.376E+05	4.692E-02
0	2	3.774E-01	5.767E-14	1.247E+05	3.879E-03
0	3	6.236E-01	3.896E-14	1.471E+05	7.720E-02
0	4	6.414E-01	5.494E-14	1.389E+05	2.125E-03
0	5	4.908E-01	7.224E-14	1.519E+05	1.114E-02

0	6	6.321E-01	8.815E-13	1.657E+05	2.958E-03
0	7	5.694E-01	4.276E-14	1.639E+05	2.387E-02
0	8	6.042E-01	2.420E-14	1.552E+05	3.797E-02
0	9	5.326E-01	7.545E-13	1.300E+05	1.071E-02
0	10	6.123E-01	1.032E-13	1.596E+05	7.509E-02
0	11	4.848E-01	3.047E-13	1.232E+05	5.824E-02
0	12	5.378E-01	2.807E-13	1.314E+05	6.795E-02
0	13	4.517E-01	1.269E-12	1.496E+05	5.603E-02
0	14	4.697E-01	1.717E-12	1.650E+05	1.636E-02
0	15	4.961E-01	1.001E-12	1.365E+05	3.509E-03
0	16	3.592E-01	2.739E-14	1.539E+05	4.604E-03
0	17	4.614E-01	3.462E-14	1.440E+05	4.983E-03
0	18	3.507E-01	2.619E-13	1.628E+05	4.099E-02
0	19	4.462E-01	6.326E-14	1.262E+05	4.063E-03
0	20	5.848E-01	1.956E-13	1.437E+05	2.075E-02
0	21	4.356E-01	1.105E-13	1.212E+05	8.339E-02
0	22	6.021E-01	1.823E-12	1.290E+05	6.480E-03
0	23	3.734E-01	1.183E-13	1.669E+05	1.504E-02
0	24	4.622E-01	3.530E-13	1.501E+05	1.162E-03
0	25	5.879E-01	1.240E-12	1.325E+05	1.758E-03
0	26	3.972E-01	1.756E-13	1.482E+05	2.168E-02
0	27	6.176E-01	4.746E-14	1.529E+05	3.431E-02
0	28	4.369E-01	2.125E-13	1.416E+05	1.242E-03
0	29	4.769E-01	4.515E-13	1.467E+05	1.235E-02
0	30	4.020E-01	2.892E-14	1.393E+05	1.044E-03
0	31	5.205E-01	1.636E-13	1.550E+05	1.514E-03
0	32	6.508E-01	1.393E-12	1.616E+05	8.345E-03
0	33	6.379E-01	7.165E-13	1.349E+05	2.734E-03
0	34	3.680E-01	5.046E-13	1.577E+05	2.059E-03
0	35	3.852E-01	8.310E-13	1.292E+05	9.827E-02
0	36	5.110E-01	1.403E-13	1.586E+05	5.841E-03
0	37	5.446E-01	8.095E-14	1.272E+05	1.436E-02
0	38	4.212E-01	2.037E-12	1.337E+05	1.640E-03
0	39	5.940E-01	4.585E-13	1.698E+05	4.841E-02
0	40	5.628E-01	7.349E-14	1.221E+05	2.895E-02
0	41	5.255E-01	2.311E-12	1.429E+05	3.174E-02
0	42	4.297E-01	6.553E-13	1.260E+05	3.182E-03
0	43	3.925E-01	1.131E-12	1.353E+05	7.959E-03
0	44	4.081E-01	1.549E-12	1.685E+05	2.561E-02
0	45	5.508E-01	2.229E-13	1.452E+05	1.843E-02
0	46	5.788E-01	5.839E-13	1.207E+05	5.565E-03
0	47	5.033E-01	9.513E-14	1.606E+05	1.395E-03
0	48	4.136E-01	1.279E-13	1.679E+05	9.489E-03
0	49	5.580E-01	3.527E-14	1.409E+05	7.395E-03
0	50	6.573E-01	3.238E-13	1.560E+05	2.317E-03

1TTITLE SDB: PARAMETER\_PROD Calc: CRA1 Ver: 1.00 10/06/03 16:10:50  
 ORANKS OF LATIN HYPERCUBE SAMPLE INPUT VECTORS

RUN NO.	X(1)	X(2)	X(3)	X(4)
0 1	27.	31.	18.	42.
0 2	5.	10.	5.	15.
0 3	45.	6.	28.	48.
0 4	48.	9.	19.	9.
0 5	23.	12.	32.	27.
0 6	46.	40.	46.	12.
0 7	36.	7.	44.	35.
0 8	42.	1.	36.	40.
0 9	30.	38.	11.	26.
0 10	43.	16.	40.	47.
0 11	22.	28.	4.	45.
0 12	31.	27.	12.	46.
0 13	17.	44.	30.	44.
0 14	20.	47.	45.	31.
0 15	24.	41.	17.	14.
0 16	2.	2.	34.	17.
0 17	18.	4.	25.	18.
0 18	1.	26.	43.	41.
0 19	16.	11.	7.	16.
0 20	38.	23.	24.	33.
0 21	14.	17.	2.	49.
0 22	41.	48.	9.	21.
0 23	4.	18.	47.	30.
0 24	19.	30.	31.	2.
0 25	39.	43.	13.	7.
0 26	8.	22.	29.	34.
0 27	44.	8.	33.	39.
0 28	15.	24.	22.	3.
0 29	21.	32.	27.	28.
0 30	9.	3.	20.	1.
0 31	28.	21.	35.	5.
0 32	49.	45.	42.	24.
0 33	47.	37.	15.	11.
0 34	3.	34.	38.	8.
0 35	6.	39.	10.	50.
0 36	26.	20.	39.	20.
0 37	32.	14.	8.	29.
0 38	12.	49.	14.	6.
0 39	40.	33.	50.	43.
0 40	35.	13.	3.	37.
0 41	29.	50.	23.	38.
0 42	13.	36.	6.	13.
0 43	7.	42.	16.	23.
0 44	10.	46.	49.	36.
0 45	33.	25.	26.	32.

```

0  46      37.      35.      1.      19.
0  47      25.      15.      41.      4.
0  48      11.      19.      48.      25.
0  49      34.      5.      21.      22.
0  50      50.      29.      37.      10.
1  TITLE SDB: PARAMETER_PROD      Calc: CRA1      Ver: 1.00      10/06/03 16:10:50
0  HISTOGRAM FOR VARIABLE NO. 1      UNIFORM      DISTRIBUTION
    
```

MIDPOINT	FREQ.
0.3525000	2 XX
0.3675000	2 XX
0.3825001	2 XX
0.3975001	3 XXX
0.4125001	2 XX
0.4275001	2 XX
0.4425001	3 XXX
0.4575001	3 XXX
0.4725001	2 XX
0.4875002	2 XX
0.5025002	2 XX
0.5175002	3 XXX
0.5325001	3 XXX
0.5475001	2 XX
0.5625001	3 XXX
0.5775001	2 XX
0.5925001	2 XX
0.6075001	3 XXX
0.6225001	2 XX
0.6375000	3 XXX
0.6525000	2 XX
0	50

MIN	MAX	RANGE	MEAN	MEDIAN	VARIANCE
0.3507164	0.6572877	0.3065713	0.5049726	0.5071500	0.7938805E-02

```

1  TITLE SDB: PARAMETER_PROD      Calc: CRA1      Ver: 1.00      10/06/03 16:10:50
0  HISTOGRAM FOR VARIABLE NO. 2      LOGUNIFORM      DISTRIBUTION
    
```

MIDPOINT	FREQ.
0.5500000E-13	16 XXXXXXXXXXXXXXXXXXXX
0.1650000E-12	8 XXXXXXXXX
0.2750000E-12	5 XXXXX
0.3850000E-12	2 XX

0.4950000E-12	3	XXX
0.6050000E-12	2	XX
0.7150000E-12	2	XX
0.8250000E-12	1	X
0.9350000E-12	1	X
0.1045000E-11	1	X
0.1155000E-11	1	X
0.1265000E-11	2	XX
0.1375000E-11	1	X
0.1485000E-11	0	
0.1595000E-11	1	X
0.1705000E-11	1	X
0.1815000E-11	1	X
0.1925000E-11	0	
0.2035000E-11	1	X
0.2145000E-11	0	
0.2255000E-11	0	
0.2365000E-11	1	X
0	50	

MIN	MAX	RANGE	MEAN	MEDIAN	VARIANCE
0.2419524E-13	0.2310924E-11	0.2286729E-11	0.5115115E-12	0.2424169E-12	0.3474150E-24

1 TITLE SDB: PARAMETER\_PROD      Calc: CRA1      Ver: 1.00      10/06/03 16:10:50  
 0 HISTOGRAM FOR VARIABLE NO. 3      UNIFORM      DISTRIBUTION

MIDPOINT	FREQ.	
121250.0	3	XXX
123750.0	2	XX
126250.0	3	XXX
128750.0	2	XX
131250.0	2	XX
133750.0	3	XXX
136250.0	2	XX
138750.0	3	XXX
141250.0	2	XX
143750.0	3	XXX
146250.0	3	XXX
148750.0	2	XX
151250.0	2	XX
153750.0	3	XXX
156250.0	2	XX
158750.0	3	XXX
161250.0	2	XX

```

163750.0      3   XXX
166250.0      2   XX
168750.0      3   XXX
0              50

```

```

      MIN          MAX          RANGE          MEAN          MEDIAN          VARIANCE
120740.1      169813.3      49073.20      145069.2      144618.5      0.2113431E+09

```

```

1  TITLE SDB: PARAMETER_PROD      Calc: CRA1      Ver: 1.00      10/06/03 16:10:50
0  HISTOGRAM FOR VARIABLE NO. 4      LOGUNIFORM      DISTRIBUTION

```

```

      MIDPOINT          FREQ.
0.2449999E-02          17   XXXXXXXXXXXXXXXXXXXX
0.7349997E-02          8   XXXXXXXXX
0.1225000E-01          4   XXXX
0.1714999E-01          3   XXX
0.2204999E-01          3   XXX
0.2694999E-01          2   XX
0.3184999E-01          1   X
0.3674999E-01          2   XX
0.4164999E-01          1   X
0.4654998E-01          2   XX
0.5144998E-01          0
0.5634998E-01          2   XX
0.6124998E-01          0
0.6614997E-01          1   X
0.7104997E-01          0
0.7594997E-01          2   XX
0.8084998E-01          0
0.8574998E-01          1   X
0.9064998E-01          0
0.9554998E-01          0
0.1004500              1   X
0                          50

```

```

      MIN          MAX          RANGE          MEAN          MEDIAN          VARIANCE
0.1044142E-02      0.9827166E-01      0.9722752E-01      0.2145984E-01      0.1010037E-01      0.6221362E-03

```

```

1TITLE SDB: PARAMETER_PROD      Calc: CRA1      Ver: 1.00      10/06/03 16:10:50
0CORRELATIONS AMONG INPUT VARIABLES CREATED BY THE LATIN HYPERCUBE SAMPLE FOR RAW DATA
0  1  1.0000
0  2  0.0045  1.0000

```



```
0 3 0.0238 -0.0319 1.0000
0 4 0.0286 -0.0737 -0.0771 1.0000
0 1 2 3 4
```

OVARIABLES

OTHE VARIANCE INFLATION FACTOR FOR THIS MATRIX IS 1.01

1TITLE SDB: PARAMETER\_PROD Calc: CRA1 Ver: 1.00 10/06/03 16:10:50

OCORRELATIONS AMONG INPUT VARIABLES CREATED BY THE LATIN HYPERCUBE SAMPLE FOR RANK DATA

PAGE 1

```
0 1 1.0000
0 2 -0.0097 1.0000
0 3 0.0281 -0.0471 1.0000
0 4 0.0678 -0.0297 0.0365 1.0000
0 1 2 3 4
```

OVARIABLES

OTHE VARIANCE INFLATION FACTOR FOR THIS MATRIX IS 1.01

**APPENDIX DEFAULTS**

The following listing was obtained by running the GROPECDB utility on the CDB output file from R1S1, v001. All property names and values are listed. Note that five of the properties (REPIPRES, REPIPOR, REPIPERM, TENSLSTR, and PARTDIAM) do not represent defaults. Rather, these correspond to the values specific to v001. All other property values remain constant throughout all 50 vectors and all 4 scenarios.

GROPECDB\_PA96

```

GGGGG RRRRRR OOOOO PPPPPP EEEEEEE CCCCC DDDDD BB BBBB          P P P P P
GG  GG RR  RR OO  OO PP  PP EE      CC  CC DD  DD BB  BB      PP  PP
GG   RR  RR OO  OO PP  PP EE      CC  CC DD  DD BB  BB      PP  PP
GG   RRRRRR OO  OO PPPPPP EEEEE  CC      DD  DD BBBB BB      P P P P P
GG  GGG RRRRR  OO  OO PP      EE      CC      DD  DD BB  BB      PP
GG  GG RR  RR OO  OO PP      EE      CC  CC DD  DD BB  BB      PP
GGGGG RR  RR OOOOO PP      EEEEEEE CCCCC DDDDD BB BBBB      PP
    
```

GROPECDB\_PA96 Version 2.12  
 PROD PA96 Built 06/27/96  
 Sponsored by Amy Gilkey

Run on 10/22/03 at 10:20:13  
 Run on ALPHA AXP CCR OpenVMS V7.3-1

Database: PAWORK:[SHARED.DLLORD.DRS.R1S1]DRS\_CRA1\_R1\_S1\_V001.CDB;1  
 Written on: 10/10/03 11:24:19

CAMDAT Version: 1 (EXODUS Version: 1)

PROPERTIES

Element Block 1) "GLOBAL " 1=ID 0 elements  
 4-node 0 attributes 0 properties

Element Block 2) "SPALLMOD" 2=ID 0 elements  
 4-node 0 attributes 36 properties

SURFELEV	REPOSTOP	REPOSTCK	DRZTCK	DRZPERM	REPOTRAD
FFSTRESS	REPIPERM	REPIPOR	BIOTBETA	POISRAT	COHESION
FRICTANG	TENSLSTR	PARTDIAM	ANNUROUG	MUDSOLMX	MUDSOLVE
REFPRS	SALTDENS	PIPEID	DRILRATE	INITBAR	MUDPRATE
DDZTHICK	DDZPERM	STPDVOLR	STPPVOLR	STPDTIME	SHAPEFAC
FRCHBETA	CHARLEN	PIPEROUG	EXITPLEN	EXITPDIA	MAXPPRES

1.03730E+03	3.84700E+02	0.00000E+00	8.50000E-01	1.00000E-15	1.92000E+01
1.49000E+07	3.96600E-13	5.16600E-01	1.00000E+00	3.80000E-01	1.40000E+05
4.58000E+01	1.37600E+05	4.69200E-02	5.00000E-05	6.15000E-01	-1.50000E+00
1.01770E+05	2.18000E+03	9.71800E-02	4.44500E-03	1.50000E-01	2.01810E-02
1.60000E-01	1.00000E-14	1.00000E+03	1.00000E+03	1.00000E+03	1.00000E-01
1.15000E-06	2.00000E-02	5.00000E-05	0.00000E+00	2.03200E-01	2.75000E+07

Element Block 3) "REFCON " 3=ID 0 elements  
 4-node 0 attributes 2 properties  
 PI GRAVACC  
 3.14159E+00 9.80665E+00

Element Block 4) "BLOWOUT " 4=ID 0 elements  
 4-node 0 attributes 3 properties  
 RGAS TREPO RHOS  
 4.11600E+03 3.00000E+02 2.65000E+03

Element Block 5) "BRINESAL" 5=ID 0 elements  
 4-node 0 attributes 1 properties  
 COMPRES  
 3.10000E-10

```

Element Block 6)  "H2      "      6=ID    0 elements
  4-node      0 attributes    1 properties
  VISCO
  8.93389E-06

Element Block 7)  "DRILLMUD"    7=ID    0 elements
  4-node      0 attributes    2 properties
  VISCO      DNSFLUID
  9.17000E-03 1.21000E+03

Element Block 8)  "BOREHOLE"    8=ID    0 elements
  4-node      0 attributes    4 properties
  DIAMMOD    PIPED      COLDIA      L1
  3.11150E-01 1.14300E-01 2.03200E-01 1.82880E+02

Element Block 9)  "DATAUSED"    9=ID    0 elements
  4-node      0 attributes    70 properties
  SURFELEV   REPOSTOP   REPOSTCK   DRZTCK      DRZPERM     REPOTRAD
  FFSTRESS   REPIPERM   REPIPOR    BIOTBETA    COHESION    FRICTANG
  TENSLSSTR  PARTDIAM  ANNUROUG   MUDSOLMX    MUDSOLVE    SALTDENS
  PIPEID     DRILRATE  MUDPRATE   DDZTHICK    DDZPERM     STPDVOLR
  STPPVOLR   STPDTIME  FRCHBETA   PIPEROUG    EXITPLEN    EXITPDIA
  MAXPPRES   PI        GRAVACC    RGAS        TREPO       REPIPRES
  FFPORPRS   POISSRAT  CHARLEN.   GASBSDEN    GASVISCO    INITMDEN
  MUDVISCO   BITDIAM   PIPEDIAM   COLRDIAM    COLRLNGT    BITABOV
  REPODR     WELLDZ    REPODDR    WELLDZ      GEOMEXP.    ALLOWFLD
  WELLSTAB   REPOSTAB  MASSDIFF   MOMDIFF.    VALIDTC.    REFPRES
  H2OCOMP    WASTDENS  SHAPPFAC   TENSVEL     BITNZNO     BITNZDIA
  CHOKEFF    CAVRADO   MINCHVEL   MINNUMLT
  1.03730E+03 3.84700E+02 1.22880E+00 8.50000E-01 1.00000E-15 1.92000E+01
  1.49000E+07 3.96600E-13 5.16600E-01 1.00000E+00 1.40000E+05 4.58000E+01
  1.37600E+05 4.69200E-02 5.00000E-05 6.15000E-01 -1.50000E+00 2.18000E+03
  9.71800E-02 4.44500E-03 2.01810E-02 1.60000E-01 1.00000E-14 1.00000E+03
  1.00000E+03 1.00000E+03 1.15000E-06 5.00000E-05 0.00000E+00 2.89396E-01
  2.75000E+07 3.14159E+00 9.80665E+00 4.11600E+03 3.00000E+02 1.00000E+07
  1.00000E+07 3.80000E-01 2.00000E-02 8.24182E-02 8.93389E-06 1.21000E+03
  9.17000E-03 3.11150E-01 1.14300E-01 2.03200E-01 1.82880E+02 1.50000E-01
  4.00000E-03 2.00000E+00 1.01000E+00 1.00000E+00 3.00000E+00 1.00000E+00
  5.00000E-02 5.00000E+00 1.00000E-04 1.00000E-02 0.00000E+00 1.01770E+05
  3.10000E-10 2.65000E+03 1.00000E-01 1.00000E+03 3.00000E+00 1.11120E-02
  9.00000E-01 1.10008E-01 1.00000E-06 5.00000E+00

Element Block 10) "REPOS  "      10=ID   609 elements (1..609)
  4-node      4 attributes    0 properties

Element Block 11) "DOWN_WB "      11=ID   326 elements (610..935)
  4-node      4 attributes    0 properties

Element Block 12) "UP_WB  "      12=ID   325 elements (936..1260)
  4-node      4 attributes    0 properties
    
```

**APPENDIX SPALL\_TABLE**

Reproduced here is the ASCII table of spall release volumes produced for the WIPP PA CUTTINGS code. The format is as follows:

```

# of vectors per scenario
# of scenarios
REPIPRES(S1)      REPIPRES(S2) ....
(S1) vector #     runtime      SPLVOL2
.....

(S2) vector #     runtime      SPLVOL2
.....
    
```

```

50
4
10000000 12000000 14000000 14800000
1.000000E+00 6.000000E+02 0.000000E+00
2.000000E+00 6.000000E+02 0.000000E+00
3.000000E+00 6.000000E+02 0.000000E+00
4.000000E+00 6.000000E+02 0.000000E+00
5.000000E+00 6.000000E+02 0.000000E+00
6.000000E+00 6.000000E+02 0.000000E+00
7.000000E+00 6.000000E+02 0.000000E+00
8.000000E+00 6.000000E+02 0.000000E+00
9.000000E+00 6.000000E+02 0.000000E+00
1.000000E+01 6.000000E+02 0.000000E+00
1.100000E+01 6.000000E+02 0.000000E+00
1.200000E+01 6.000000E+02 0.000000E+00
1.300000E+01 6.000000E+02 0.000000E+00
1.400000E+01 6.000000E+02 0.000000E+00
1.500000E+01 6.000000E+02 0.000000E+00
1.600000E+01 6.000000E+02 0.000000E+00
1.700000E+01 6.000000E+02 0.000000E+00
1.800000E+01 6.000000E+02 0.000000E+00
1.900000E+01 6.000000E+02 0.000000E+00
2.000000E+01 6.000000E+02 0.000000E+00
2.100000E+01 6.000000E+02 0.000000E+00
2.200000E+01 6.000000E+02 0.000000E+00
2.300000E+01 6.000000E+02 0.000000E+00
2.400000E+01 6.000000E+02 0.000000E+00
2.500000E+01 6.000000E+02 0.000000E+00
2.600000E+01 6.000000E+02 0.000000E+00
2.700000E+01 6.000000E+02 0.000000E+00
2.800000E+01 6.000000E+02 0.000000E+00
2.900000E+01 6.000000E+02 0.000000E+00
3.000000E+01 6.000000E+02 0.000000E+00
3.100000E+01 6.000000E+02 0.000000E+00
3.200000E+01 6.000000E+02 0.000000E+00
3.300000E+01 6.000000E+02 0.000000E+00
3.400000E+01 6.000000E+02 0.000000E+00
3.500000E+01 6.000000E+02 0.000000E+00
3.600000E+01 6.000000E+02 0.000000E+00
3.700000E+01 6.000000E+02 0.000000E+00
    
```

3.800000E+01	6.000000E+02	0.000000E+00
3.900000E+01	6.000000E+02	0.000000E+00
4.000000E+01	6.000000E+02	0.000000E+00
4.100000E+01	6.000000E+02	0.000000E+00
4.200000E+01	6.000000E+02	0.000000E+00
4.300000E+01	6.000000E+02	0.000000E+00
4.400000E+01	6.000000E+02	0.000000E+00
4.500000E+01	6.000000E+02	0.000000E+00
4.600000E+01	6.000000E+02	0.000000E+00
4.700000E+01	6.000000E+02	0.000000E+00
4.800000E+01	6.000000E+02	0.000000E+00
4.900000E+01	6.000000E+02	0.000000E+00
5.000000E+01	6.000000E+02	0.000000E+00
1.000000E+00	6.000000E+02	0.000000E+00
2.000000E+00	6.000000E+02	1.219309E+00
3.000000E+00	6.000000E+02	0.000000E+00
4.000000E+00	6.000000E+02	5.647984E-01
5.000000E+00	6.000000E+02	0.000000E+00
6.000000E+00	6.000000E+02	0.000000E+00
7.000000E+00	6.000000E+02	0.000000E+00
8.000000E+00	6.000000E+02	0.000000E+00
9.000000E+00	6.000000E+02	0.000000E+00
1.000000E+01	6.000000E+02	0.000000E+00
1.100000E+01	6.000000E+02	0.000000E+00
1.200000E+01	6.000000E+02	0.000000E+00
1.300000E+01	6.000000E+02	0.000000E+00
1.400000E+01	6.000000E+02	0.000000E+00
1.500000E+01	6.000000E+02	0.000000E+00
1.600000E+01	6.000000E+02	1.708426E+00
1.700000E+01	6.000000E+02	0.000000E+00
1.800000E+01	6.000000E+02	0.000000E+00
1.900000E+01	6.000000E+02	6.072450E-01
2.000000E+01	6.000000E+02	7.934533E-03
2.100000E+01	6.000000E+02	0.000000E+00
2.200000E+01	6.000000E+02	0.000000E+00
2.300000E+01	6.000000E+02	1.665951E-01
2.400000E+01	6.000000E+02	0.000000E+00
2.500000E+01	6.000000E+02	0.000000E+00
2.600000E+01	6.000000E+02	1.392531E-01
2.700000E+01	6.000000E+02	0.000000E+00
2.800000E+01	6.000000E+02	3.465368E-02
2.900000E+01	6.000000E+02	0.000000E+00
3.000000E+01	6.000000E+02	7.000460E+00
3.100000E+01	6.000000E+02	9.779406E-02
3.200000E+01	6.000000E+02	0.000000E+00
3.300000E+01	6.000000E+02	0.000000E+00
3.400000E+01	6.000000E+02	0.000000E+00
3.500000E+01	6.000000E+02	0.000000E+00
3.600000E+01	6.000000E+02	1.828914E-01
3.700000E+01	6.000000E+02	0.000000E+00
3.800000E+01	6.000000E+02	0.000000E+00
3.900000E+01	6.000000E+02	0.000000E+00
4.000000E+01	6.000000E+02	0.000000E+00
4.100000E+01	6.000000E+02	0.000000E+00
4.200000E+01	6.000000E+02	0.000000E+00
4.300000E+01	6.000000E+02	0.000000E+00
4.400000E+01	6.000000E+02	0.000000E+00
4.500000E+01	6.000000E+02	0.000000E+00
4.600000E+01	6.000000E+02	0.000000E+00
4.700000E+01	6.000000E+02	2.443149E-01
4.800000E+01	6.000000E+02	2.241325E-01
4.900000E+01	6.000000E+02	0.000000E+00
5.000000E+01	6.000000E+02	0.000000E+00
1.000000E+00	6.000000E+02	3.969786E-01
2.000000E+00	6.000000E+02	7.218000E+00
3.000000E+00	6.000000E+02	0.000000E+00
4.000000E+00	6.000000E+02	1.288459E+00
5.000000E+00	6.000000E+02	7.992458E-02
6.000000E+00	6.000000E+02	7.098113E-02

7.000000E+00	6.000000E+02	0.000000E+00
8.000000E+00	6.000000E+02	0.000000E+00
9.000000E+00	6.000000E+02	1.893962E-01
1.000000E+01	6.000000E+02	0.000000E+00
1.100000E+01	6.000000E+02	2.772627E-01
1.200000E+01	6.000000E+02	4.027504E-02
1.300000E+01	6.000000E+02	1.027906E-01
1.400000E+01	6.000000E+02	3.571318E-02
1.500000E+01	6.000000E+02	1.126825E-01
1.600000E+01	6.000000E+02	3.130843E+00
1.700000E+01	6.000000E+02	9.304333E-02
1.800000E+01	6.000000E+02	6.011905E-01
1.900000E+01	6.000000E+02	4.405089E+00
2.000000E+01	6.000000E+02	2.248029E-01
2.100000E+01	6.000000E+02	0.000000E+00
2.200000E+01	6.000000E+02	2.612711E-02
2.300000E+01	6.000000E+02	1.788106E+00
2.400000E+01	6.000000E+02	4.610163E-01
2.500000E+01	6.000000E+02	6.482388E-02
2.600000E+01	6.000000E+02	1.033008E+00
2.700000E+01	6.000000E+02	0.000000E+00
2.800000E+01	6.000000E+02	7.382768E-01
2.900000E+01	6.000000E+02	3.845654E-01
3.000000E+01	6.000000E+02	9.452960E+00
3.100000E+01	6.000000E+02	6.942384E-01
3.200000E+01	6.000000E+02	2.364516E-02
3.300000E+01	6.000000E+02	1.207344E-01
3.400000E+01	6.000000E+02	4.061748E-01
3.500000E+01	6.000000E+02	2.688929E-01
3.600000E+01	6.000000E+02	9.488029E-01
3.700000E+01	6.000000E+02	0.000000E+00
3.800000E+01	6.000000E+02	5.156692E-02
3.900000E+01	6.000000E+02	2.100307E-01
4.000000E+01	6.000000E+02	0.000000E+00
4.100000E+01	6.000000E+02	9.508261E-03
4.200000E+01	6.000000E+02	3.110759E-01
4.300000E+01	6.000000E+02	1.570537E-01
4.400000E+01	6.000000E+02	6.952912E-02
4.500000E+01	6.000000E+02	4.843711E-01
4.600000E+01	6.000000E+02	2.243195E-01
4.700000E+01	6.000000E+02	1.809723E+00
4.800000E+01	6.000000E+02	1.336131E+00
4.900000E+01	6.000000E+02	0.000000E+00
5.000000E+01	6.000000E+02	3.235973E-01
1.000000E+00	6.000000E+02	5.573982E-01
2.000000E+00	6.000000E+02	7.297470E+00
3.000000E+00	6.000000E+02	0.000000E+00
4.000000E+00	6.000000E+02	1.610650E+00
5.000000E+00	6.000000E+02	2.073942E-01
6.000000E+00	6.000000E+02	1.825025E-01
7.000000E+00	6.000000E+02	0.000000E+00
8.000000E+00	6.000000E+02	0.000000E+00
9.000000E+00	6.000000E+02	3.403259E-01
1.000000E+01	6.000000E+02	0.000000E+00
1.100000E+01	6.000000E+02	3.810624E-01
1.200000E+01	6.000000E+02	9.223854E-02
1.300000E+01	6.000000E+02	2.163116E-01
1.400000E+01	6.000000E+02	1.372680E-01
1.500000E+01	6.000000E+02	2.696921E-01
1.600000E+01	6.000000E+02	3.952352E+00
1.700000E+01	6.000000E+02	3.760077E-01
1.800000E+01	6.000000E+02	1.170028E+00
1.900000E+01	6.000000E+02	5.317553E+00
2.000000E+01	6.000000E+02	3.182866E-01
2.100000E+01	6.000000E+02	0.000000E+00
2.200000E+01	6.000000E+02	1.082159E-01
2.300000E+01	6.000000E+02	2.248536E+00
2.400000E+01	6.000000E+02	6.337715E-01
2.500000E+01	6.000000E+02	1.654469E-01
2.600000E+01	6.000000E+02	1.206204E+01

2.700000E+01	6.000000E+02	0.000000E+00
2.800000E+01	6.000000E+02	1.452345E+00
2.900000E+01	6.000000E+02	4.869126E-01
3.000000E+01	6.000000E+02	1.206204E+01
3.100000E+01	6.000000E+02	1.427621E+00
3.200000E+01	6.000000E+02	9.781100E-02
3.300000E+01	6.000000E+02	2.572754E-01
3.400000E+01	6.000000E+02	6.018938E-01
3.500000E+01	6.000000E+02	4.417713E-01
3.600000E+01	6.000000E+02	1.670775E+00
3.700000E+01	6.000000E+02	0.000000E+00
3.800000E+01	6.000000E+02	1.609376E-01
3.900000E+01	6.000000E+02	3.452956E-01
4.000000E+01	6.000000E+02	0.000000E+00
4.100000E+01	6.000000E+02	8.979040E-02
4.200000E+01	6.000000E+02	5.206025E-01
4.300000E+01	6.000000E+02	3.251399E-01
4.400000E+01	6.000000E+02	1.797236E-01
4.500000E+01	6.000000E+02	6.526521E-01
4.600000E+01	6.000000E+02	4.319749E-01
4.700000E+01	6.000000E+02	3.105359E+00
4.800000E+01	6.000000E+02	2.329654E+00
4.900000E+01	6.000000E+02	0.000000E+00
5.000000E+01	6.000000E+02	5.460343E-01

533157

date: November 18, 2003

to: Cliff Hansen  
TSPA Team Lead, SNL org 6821

from: David Lord *David L Lord*  
Spallings model PI, SNL org 6821

subject: Correction of error in Oct. 16 2003 generation of table of spallings volumes

The purpose of this memo is to: (1) identify an error found in the table "SUM\_DRS\_SPLVOL2.TBL" stored in the CMS Library PACMS2:[CMS.CMS\_CRA1.CRA1\_DRS], (2) show the impacts of the error on the spallings CCDFs, and (3) outline a strategy for correcting the error and preventing such errors in the future.

The file in question is an ASCII table of 200 spallings volumes generated from DRSPALL output, formatted for input to CUTTINGS\_S. One of the 200 values was found to be in error. Construction of this table requires both automated and manual steps. The error was introduced during a manual step, and was not flagged in technical review.

**(1) Identification of error**

A listing of the file SUM\_DRS\_SPLVOL2.TBL is given in the appendix. Relevant to this discussion is a typo in line 186. Lines 184-188 are reproduced here for clarity:

vector	time	spallvol
line 183.....		
2.400000E+01	6.000000E+02	6.337715E-01
2.500000E+01	6.000000E+02	1.654469E-01
2.600000E+01	6.000000E+02	1.206204E+01
2.700000E+01	6.000000E+02	0.000000E+00
2.800000E+01	6.000000E+02	1.452345E+00
line 189.....		

Line 186 should show spallvol = 1.794724E+00, the value resulting directly from execution of the DRSPALL code. Instead, it shows spallvol = 1.206204E+01, a typo inserted manually during final formatting of this ASCII file.

These data define the spall volumes attributed to DRSPALL vectors at 4 selected pressures (10, 12, 14, and 14.8 MPa). CUTTINGS\_S uses this table to map DRSPALL vectors to BRAGFLO vectors for single intrusion release values. CCDFGF uses these data to build total releases for multiple intrusions.

**(2) Impacts of error**

The impacts of this error on TSPA are relatively small. Each DRSPALL vector is mapped to two BRAGFLO vectors, so this error in one DRSPALL vector can affect two BRAGFLO vectors per replicate. Also, the error is isolated to intrusions where P > 14 MPa.

The family of spallings CCDFs for replicate 2 are shown in Figure 1. Each curve represents one vector. The two vectors affected by this error are labeled on the figure. These appear as high-release vectors. Correction of the error would shift these two curves to the left by lowering the releases (i.e., the impact of 1.7m<sup>3</sup> per



high-pressure intrusion versus  $12.1 \text{ m}^3$ ). The error is therefore conservative with respect to releases. This figure was built for our Sensitivity & Uncertainty Analysis Report for spallings releases in the CRA, but has not been published yet.

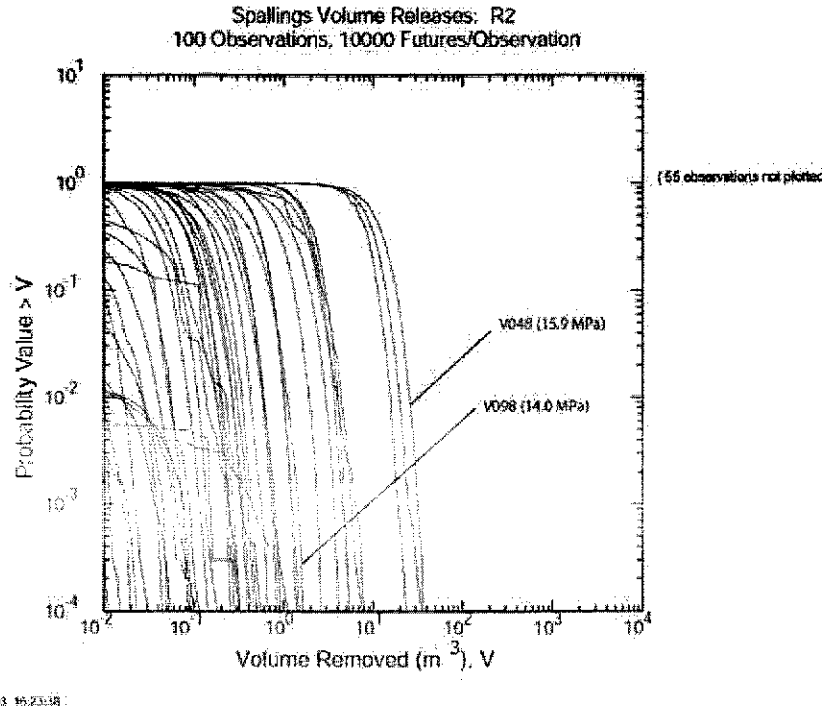

Figure 1. CCDFs for spallings releases in CRA replicate 2. Erroneous vectors are identified.

Another impact would be in the single-intrusion scatterplots, one of which was generated for the Appendix PA write-up on spallings releases, reproduced here in Figure 2. Correction of the error would shift the point at (partdiam = 22, splvol = 12) to (partdiam = 22, splvol = 1.7).

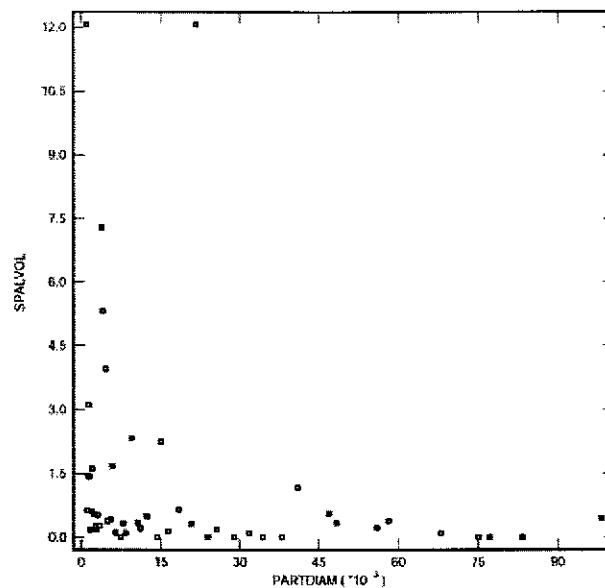

Figure 2. Scatterplot of single-intrusion spall volume release versus particle diameter. Note spurious point at partdiam ~ 22mm, splvol =  $12 \text{ m}^3$ .

The following CRA PA Documents are affected by this error

- 1) Spallings Sensitivity Analysis - Part I (complete, will be revised)
- 2) Spallings Sensitivity Analysis - Part II (draft)
- 3) Analysis Package for CCDFGF (draft)
- 4) CRA Run Control (draft)
- 5) CRA Chapter 6 Section 6.5 (CCDF figures for total releases only) (draft)
- 6) Appendix PA Section 8 (figures for spallings volume and sensitivity analysis) (draft)
- 7) Appendix PA Section 9 (figures for total releases, spallings release, and sensitivity analysis) (draft)

**(3) Strategy for correcting error and avoiding repeat in the future.**

Correction of the error is simple. We would edit the ASCII file to replace the erroneous value, and re-run CUTTINGS\_S and CCDFGF.

A strategy to avoid this in the future is to:

- 1) note the number of manual changes to splvol values necessary in the SUMMARIZE output file (5 in the current case) to convert it to a CUTTINGS\_S input file
- 2) implement the changes manually
- 3) use the VMS command DIFF to compare the original summarize file with the edited summarize file (now the CUTTINGS input file) to confirm that 5 changes were made, and the changes fall in the right spot with the right values

This strategy would have caught the error in SUM\_DRS\_SPLVOL2.TBL where 6 changes were made instead of the prescribed 5.

1 Appendix  
2 Listing of file SUM\_DRS\_SPLVOL2.TBL

3  
4  
5 50

6 4

7	1000000	1200000	1400000	1480000
8	1.000000E+00	6.000000E+02	0.000000E+00	
9	2.000000E+00	6.000000E+02	0.000000E+00	
10	3.000000E+00	6.000000E+02	0.000000E+00	
11	4.000000E+00	6.000000E+02	0.000000E+00	
12	5.000000E+00	6.000000E+02	0.000000E+00	
13	6.000000E+00	6.000000E+02	0.000000E+00	
14	7.000000E+00	6.000000E+02	0.000000E+00	
15	8.000000E+00	6.000000E+02	0.000000E+00	
16	9.000000E+00	6.000000E+02	0.000000E+00	
17	1.000000E+01	6.000000E+02	0.000000E+00	
18	1.100000E+01	6.000000E+02	0.000000E+00	
19	1.200000E+01	6.000000E+02	0.000000E+00	
20	1.300000E+01	6.000000E+02	0.000000E+00	
21	1.400000E+01	6.000000E+02	0.000000E+00	
22	1.500000E+01	6.000000E+02	0.000000E+00	
23	1.600000E+01	6.000000E+02	0.000000E+00	
24	1.700000E+01	6.000000E+02	0.000000E+00	
25	1.800000E+01	6.000000E+02	0.000000E+00	
26	1.900000E+01	6.000000E+02	0.000000E+00	
27	2.000000E+01	6.000000E+02	0.000000E+00	
28	2.100000E+01	6.000000E+02	0.000000E+00	
29	2.200000E+01	6.000000E+02	0.000000E+00	
30	2.300000E+01	6.000000E+02	0.000000E+00	
31	2.400000E+01	6.000000E+02	0.000000E+00	
32	2.500000E+01	6.000000E+02	0.000000E+00	
33	2.600000E+01	6.000000E+02	0.000000E+00	
34	2.700000E+01	6.000000E+02	0.000000E+00	
35	2.800000E+01	6.000000E+02	0.000000E+00	
36	2.900000E+01	6.000000E+02	0.000000E+00	
37	3.000000E+01	6.000000E+02	0.000000E+00	
38	3.100000E+01	6.000000E+02	0.000000E+00	
39	3.200000E+01	6.000000E+02	0.000000E+00	
40	3.300000E+01	6.000000E+02	0.000000E+00	
41	3.400000E+01	6.000000E+02	0.000000E+00	
42	3.500000E+01	6.000000E+02	0.000000E+00	
43	3.600000E+01	6.000000E+02	0.000000E+00	
44	3.700000E+01	6.000000E+02	0.000000E+00	
45	3.800000E+01	6.000000E+02	0.000000E+00	
46	3.900000E+01	6.000000E+02	0.000000E+00	
47	4.000000E+01	6.000000E+02	0.000000E+00	
48	4.100000E+01	6.000000E+02	0.000000E+00	
49	4.200000E+01	6.000000E+02	0.000000E+00	
50	4.300000E+01	6.000000E+02	0.000000E+00	
51	4.400000E+01	6.000000E+02	0.000000E+00	
52	4.500000E+01	6.000000E+02	0.000000E+00	
53	4.600000E+01	6.000000E+02	0.000000E+00	
54	4.700000E+01	6.000000E+02	0.000000E+00	
55	4.800000E+01	6.000000E+02	0.000000E+00	

56	4.900000E+01	6.000000E+02	0.000000E+00
57	5.000000E+01	6.000000E+02	0.000000E+00
58			
59	1.000000E+00	6.000000E+02	0.000000E+00
60	2.000000E+00	6.000000E+02	1.219309E+00
61	3.000000E+00	6.000000E+02	0.000000E+00
62	4.000000E+00	6.000000E+02	5.647984E-01
63	5.000000E+00	6.000000E+02	0.000000E+00
64	6.000000E+00	6.000000E+02	0.000000E+00
65	7.000000E+00	6.000000E+02	0.000000E+00
66	8.000000E+00	6.000000E+02	0.000000E+00
67	9.000000E+00	6.000000E+02	0.000000E+00
68	1.000000E+01	6.000000E+02	0.000000E+00
69	1.100000E+01	6.000000E+02	0.000000E+00
70	1.200000E+01	6.000000E+02	0.000000E+00
71	1.300000E+01	6.000000E+02	0.000000E+00
72	1.400000E+01	6.000000E+02	0.000000E+00
73	1.500000E+01	6.000000E+02	0.000000E+00
74	1.600000E+01	6.000000E+02	1.708426E+00
75	1.700000E+01	6.000000E+02	0.000000E+00
76	1.800000E+01	6.000000E+02	0.000000E+00
77	1.900000E+01	6.000000E+02	6.072450E-01
78	2.000000E+01	6.000000E+02	7.934533E-03
79	2.100000E+01	6.000000E+02	0.000000E+00
80	2.200000E+01	6.000000E+02	0.000000E+00
81	2.300000E+01	6.000000E+02	1.665951E-01
82	2.400000E+01	6.000000E+02	0.000000E+00
83	2.500000E+01	6.000000E+02	0.000000E+00
84	2.600000E+01	6.000000E+02	1.392531E-01
85	2.700000E+01	6.000000E+02	0.000000E+00
86	2.800000E+01	6.000000E+02	3.465368E-02
87	2.900000E+01	6.000000E+02	0.000000E+00
88	3.000000E+01	6.000000E+02	7.000460E+00
89	3.100000E+01	6.000000E+02	9.779406E-02
90	3.200000E+01	6.000000E+02	0.000000E+00
91	3.300000E+01	6.000000E+02	0.000000E+00
92	3.400000E+01	6.000000E+02	0.000000E+00
93	3.500000E+01	6.000000E+02	0.000000E+00
94	3.600000E+01	6.000000E+02	1.828914E-01
95	3.700000E+01	6.000000E+02	0.000000E+00
96	3.800000E+01	6.000000E+02	0.000000E+00
97	3.900000E+01	6.000000E+02	0.000000E+00
98	4.000000E+01	6.000000E+02	0.000000E+00
99	4.100000E+01	6.000000E+02	0.000000E+00
100	4.200000E+01	6.000000E+02	0.000000E+00
101	4.300000E+01	6.000000E+02	0.000000E+00
102	4.400000E+01	6.000000E+02	0.000000E+00
103	4.500000E+01	6.000000E+02	0.000000E+00
104	4.600000E+01	6.000000E+02	0.000000E+00
105	4.700000E+01	6.000000E+02	2.443149E-01
106	4.800000E+01	6.000000E+02	2.241325E-01
107	4.900000E+01	6.000000E+02	0.000000E+00
108	5.000000E+01	6.000000E+02	0.000000E+00

109  
110 1.000000E+00 6.000000E+02 3.969786E-01  
111 2.000000E+00 6.000000E+02 7.218000+00  
112 3.000000E+00 6.000000E+02 0.000000E+00  
113 4.000000E+00 6.000000E+02 1.288459E+00  
114 5.000000E+00 6.000000E+02 7.992458E-02  
115 6.000000E+00 6.000000E+02 7.098113E-02  
116 7.000000E+00 6.000000E+02 0.000000E+00  
117 8.000000E+00 6.000000E+02 0.000000E+00  
118 9.000000E+00 6.000000E+02 1.893962E-01  
119 1.000000E+01 6.000000E+02 0.000000E+00  
120 1.100000E+01 6.000000E+02 2.772627E-01  
121 1.200000E+01 6.000000E+02 4.027504E-02  
122 1.300000E+01 6.000000E+02 1.027906E-01  
123 1.400000E+01 6.000000E+02 3.571318E-02  
124 1.500000E+01 6.000000E+02 1.126825E-01  
125 1.600000E+01 6.000000E+02 3.130843E+00  
126 1.700000E+01 6.000000E+02 9.304333E-02  
127 1.800000E+01 6.000000E+02 6.011905E-01  
128 1.900000E+01 6.000000E+02 4.405089E+00  
129 2.000000E+01 6.000000E+02 2.248029E-01  
130 2.100000E+01 6.000000E+02 0.000000E+00  
131 2.200000E+01 6.000000E+02 2.612711E-02  
132 2.300000E+01 6.000000E+02 1.788106E+00  
133 2.400000E+01 6.000000E+02 4.610163E-01  
134 2.500000E+01 6.000000E+02 6.482388E-02  
135 2.600000E+01 6.000000E+02 1.033008E+00  
136 2.700000E+01 6.000000E+02 0.000000E+00  
137 2.800000E+01 6.000000E+02 7.382768E-01  
138 2.900000E+01 6.000000E+02 3.845654E-01  
139 3.000000E+01 6.000000E+02 9.452960E+00  
140 3.100000E+01 6.000000E+02 6.942384E-01  
141 3.200000E+01 6.000000E+02 2.364516E-02  
142 3.300000E+01 6.000000E+02 1.207344E-01  
143 3.400000E+01 6.000000E+02 4.061748E-01  
144 3.500000E+01 6.000000E+02 2.688929E-01  
145 3.600000E+01 6.000000E+02 9.488029E-01  
146 3.700000E+01 6.000000E+02 0.000000E+00  
147 3.800000E+01 6.000000E+02 5.156692E-02  
148 3.900000E+01 6.000000E+02 2.100307E-01  
149 4.000000E+01 6.000000E+02 0.000000E+00  
150 4.100000E+01 6.000000E+02 9.508261E-03  
151 4.200000E+01 6.000000E+02 3.110759E-01  
152 4.300000E+01 6.000000E+02 1.570537E-01  
153 4.400000E+01 6.000000E+02 6.952912E-02  
154 4.500000E+01 6.000000E+02 4.843711E-01  
155 4.600000E+01 6.000000E+02 2.243195E-01  
156 4.700000E+01 6.000000E+02 1.809723E+00  
157 4.800000E+01 6.000000E+02 1.336131E+00  
158 4.900000E+01 6.000000E+02 0.000000E+00  
159 5.000000E+01 6.000000E+02 3.235973E-01  
160  
161 1.000000E+00 6.000000E+02 5.573982E-01

162	2.000000E+00	6.000000E+02	7.297470E+00
163	3.000000E+00	6.000000E+02	0.000000E+00
164	4.000000E+00	6.000000E+02	1.610650E+00
165	5.000000E+00	6.000000E+02	2.073942E-01
166	6.000000E+00	6.000000E+02	1.825025E-01
167	7.000000E+00	6.000000E+02	0.000000E+00
168	8.000000E+00	6.000000E+02	0.000000E+00
169	9.000000E+00	6.000000E+02	3.403259E-01
170	1.000000E+01	6.000000E+02	0.000000E+00
171	1.100000E+01	6.000000E+02	3.810624E-01
172	1.200000E+01	6.000000E+02	9.223854E-02
173	1.300000E+01	6.000000E+02	2.163116E-01
174	1.400000E+01	6.000000E+02	1.372680E-01
175	1.500000E+01	6.000000E+02	2.696921E-01
176	1.600000E+01	6.000000E+02	3.952352E+00
177	1.700000E+01	6.000000E+02	3.760077E-01
178	1.800000E+01	6.000000E+02	1.170028E+00
179	1.900000E+01	6.000000E+02	5.317553E+00
180	2.000000E+01	6.000000E+02	3.182866E-01
181	2.100000E+01	6.000000E+02	0.000000E+00
182	2.200000E+01	6.000000E+02	1.082159E-01
183	2.300000E+01	6.000000E+02	2.248536E+00
184	2.400000E+01	6.000000E+02	6.337715E-01
185	2.500000E+01	6.000000E+02	1.654469E-01
186	2.600000E+01	6.000000E+02	1.206204E+01
187	2.700000E+01	6.000000E+02	0.000000E+00
188	2.800000E+01	6.000000E+02	1.452345E+00
189	2.900000E+01	6.000000E+02	4.869126E-01
190	3.000000E+01	6.000000E+02	1.206204E+01
191	3.100000E+01	6.000000E+02	1.427621E+00
192	3.200000E+01	6.000000E+02	9.781100E-02
193	3.300000E+01	6.000000E+02	2.572754E-01
194	3.400000E+01	6.000000E+02	6.018938E-01
195	3.500000E+01	6.000000E+02	4.417713E-01
196	3.600000E+01	6.000000E+02	1.670775E+00
197	3.700000E+01	6.000000E+02	0.000000E+00
198	3.800000E+01	6.000000E+02	1.609376E-01
199	3.900000E+01	6.000000E+02	3.452956E-01
200	4.000000E+01	6.000000E+02	0.000000E+00
201	4.100000E+01	6.000000E+02	8.979040E-02
202	4.200000E+01	6.000000E+02	5.206025E-01
203	4.300000E+01	6.000000E+02	3.251399E-01
204	4.400000E+01	6.000000E+02	1.797236E-01
205	4.500000E+01	6.000000E+02	6.526521E-01
206	4.600000E+01	6.000000E+02	4.319749E-01
207	4.700000E+01	6.000000E+02	3.105359E+00
208	4.800000E+01	6.000000E+02	2.329654E+00
209	4.900000E+01	6.000000E+02	0.000000E+00
210	5.000000E+01	6.000000E+02	5.460343E-01
211			
212			